

TeSys[®] U LUCM and LUCMT Multifunction Control Unit User Guide

03/2009



1743237

www.schneider-electric.com

Schneider
Electric

Schneider Electric assumes no responsibility for any errors that may appear in this document. If you have any suggestions for improvements or amendments or have found errors in this publication, please notify us.

No part of this document may be reproduced in any form or by any means, electronic or mechanical, including photocopying, without express written permission of Schneider Electric.

All pertinent state, regional, and local safety regulations must be observed when installing and using this product. For reasons of safety and to help ensure compliance with documented system data, only the manufacturer should perform repairs to components.

When devices are used for applications with technical safety requirements, the relevant instructions must be followed.

Failure to use Schneider Electric software or approved software with our hardware products may result in injury, harm, or improper operating results.

Failure to observe this information can result in injury or equipment damage.

© 2009 Schneider Electric. All rights reserved.

Table of Contents



	Safety Information	5
	About the Book	7
Chapter 1	Installation	9
	Safety Instructions	10
	General	11
	Overview of the Multifunction Control Unit	12
	Installation and service temperature	14
	Connection	15
Chapter 2	Quick start	17
	Actions for quick set-up	18
	Default Settings and Optional Values of the LUCM	20
	Default Settings and Optional Values of the LUCMT	23
Chapter 3	Detailed Startup and Adjustments During Use	27
	Organization of the interface	28
	Power up and operating modes	31
	'Config Menu' Program	33
	'Main Menu' program	38
	1_Reference sub-program	39
	Sub-Program 2_Display	40
	Sub-Program 3_Setup	41
	Sub-program 4_AdvSetup	45
	Sub-program 5_CommSetup	54
	Sub-program 6_Module	56
	Sub-program 7_Statistics	58
	Sub-program 8_Password	60
	Start-up Phase	62
Chapter 4	Warning and fault management	65
	Warning Management	66
	Fault Management	67
Chapter 5	Additional information	71
	Thermal trigger and reset graphs	72
	Powersuite Firmware Workshop	77
	Technical Characteristics	78
Glossary	81
Index	83



Safety Information

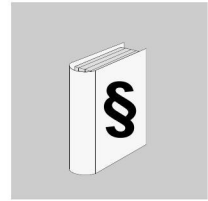

Important Information

NOTICE

Read these instructions carefully, and look at the equipment to become familiar with the device before trying to install, operate, or maintain it. The following special messages may appear throughout this documentation or on the equipment to warn of potential hazards or to call attention to information that clarifies or simplifies a procedure.



The addition of this symbol to a Danger or Warning safety label indicates that an electrical hazard exists, which will result in personal injury if the instructions are not followed.



This is the safety alert symbol. It is used to alert you to potential personal injury hazards. Obey all safety messages that follow this symbol to avoid possible injury or death.

DANGER

DANGER indicates an imminently hazardous situation which, if not avoided, **will result in** death or serious injury.

WARNING

WARNING indicates a potentially hazardous situation which, if not avoided, **can result in** death or serious injury.

CAUTION

CAUTION indicates a potentially hazardous situation which, if not avoided, **can result in** minor or moderate injury.

CAUTION

CAUTION, used without the safety alert symbol, indicates a potentially hazardous situation which, if not avoided, **can result in** equipment damage.

PLEASE NOTE

Electrical equipment should be installed, operated, serviced, and maintained only by qualified personnel. No responsibility is assumed by Schneider Electric for any consequences arising out of the use of this material.

A qualified person is one who has skills and knowledge related to the construction and operation of electrical equipment and the installation, and has received safety training to recognize and avoid the hazards involved.



About the Book

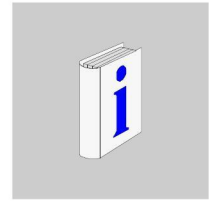

At a Glance

Document Scope

This guide describes the implementation, features, and operation of multifunction control units. By convention, they are called LUCM and LUCMT:

LUCM (or LUCM••)	represents LUCM••BL, i.e., LUCMX6BL, LUCM1XBL, LUCM05BL, LUCM12BL, LUCM18BL and LUCM32BL
LUCMT (or LUCMT••)	represents LUCMT1BL

Scope of application: Installers, design offices, maintenance personnel.

Validity Note

This document applies to all versions of LUCM/LUCMT.

Usage restrictions in regard to functions which are not available in every version of LUCM/LUCMT are indicated in this document.

Related Documents

Title of Documentation	Reference Number
LUCM/LUCMT/LUCBT/LUCDT Control Units - Instruction Sheet	AAV40504
LU•B/LU•S• TeSys U Starters - Instruction Sheet	1629984
LUTM• TeSys U Controller - User Guide	1743233
LUTM• TeSys U Controller - Instruction Sheet	1743236

You can download these technical publications and other technical information from our website at www.schneider-electric.com.

User Comments

We welcome your comments about this document. You can reach us by e-mail at techcomm@schneider-electric.com.



Installation

1

What's in this Chapter?

This chapter contains the following topics:

Topic	Page
Safety Instructions	10
General	11
Overview of the Multifunction Control Unit	12
Installation and service temperature	14
Connection	15

Safety Instructions

General Instructions

WARNING

RISK OF UNINTENDED OPERATION

These devices must be installed, configured, and used by qualified personnel only.

Users must follow the recommendations, standards, and regulations in force.

Check the function settings before starting the motor.

Do not damage or modify the devices.

Failure to follow these instructions can result in death, serious injury, or equipment damage.

CAUTION

DATA TRANSMISSION IN THE TIME ALLOWED IS NOT GUARANTEED

Only use the serial link for sending information that is not critical for the application.

Data concerning the statuses and values of load currents for the motor-starter are sent with a certain delay. As a result, this information must not be used when performing safety measures and emergency stops.

Information such as Start direction 1 and direction 2, Stop should not be used in safety circuits and emergency stops.

Failure to follow these instructions can result in injury or equipment damage.

General

Multifunction control units are referenced according to the bases they are installed on:

LUCM	for LUCM••BL units mounted on a power base (LU•B•• or LU•S••), i.e. LUCMX6BL, LUCM1XBL, LUCM05BL, LUCM12BL, LUCM18BL and LUCM32BL
LUCMT	for LUCMT1BL units mounted on a control base (LUTM••)

The LUCM multifunction control unit controls, protects, and monitors the following TeSys U products:

- LU•B•• starter-controllers with built-in short-circuit protection device
- LU•S•• starters without built-in short-circuit protection device

NOTE: LUCM multifunction control units must be used with alternating current motors only.

The LUCMT multifunction control unit only protects and monitors the following TeSys U products:

- LUTM•• controllers

NOTE: LUCMT multifunction control units must be used with three-phase alternating current motors only.

Protection Functions

The LUCM or LUCMT multifunction control units perform the following protection functions:

- Protection against over-currents (protection not provided by LUCMT)
- Protection against thermal overloads, with choice of trip class from 5 to 30
- Protection against ground faults
- Protection against phase imbalances
- Protection against mechanical jams during or after the start-up phase.
- Protection against idling
- Tripping of the starter via an external signal (as an option)

Warning Functions

The LUCM or LUCMT multifunction control units include a warning associated with each protection function.

The warning level can be configured and is independent from the protection trip level.

Diagnostic Functions

The LUCM or LUCMT multifunction control unit records and displays:

- The number of operating hours for the motor
- The number of starts
- The number of trips
- The cause of the trip

For the last five trips, the multifunction control unit records the status of the motor-starter at the time of the trip (value of currents, thermal status, and trip type).

Configuration and Monitoring

The protection, warning, and diagnostic functions may be configured and monitored:

Locally, using the built-in display and keyboard

Remotely, using:

- A PC with the PowerSuite software (VW3A8104)
- A pocket PC with the PowerSuite software (VW3A8102)
- An RJ-45 communication port, Modbus RS 485
- An XBT NU 400 communication terminal mounted on a cabinet door

Overview of the Multifunction Control Unit

Description of the Multifunction Control Unit

Front panel of the multifunction control unit:

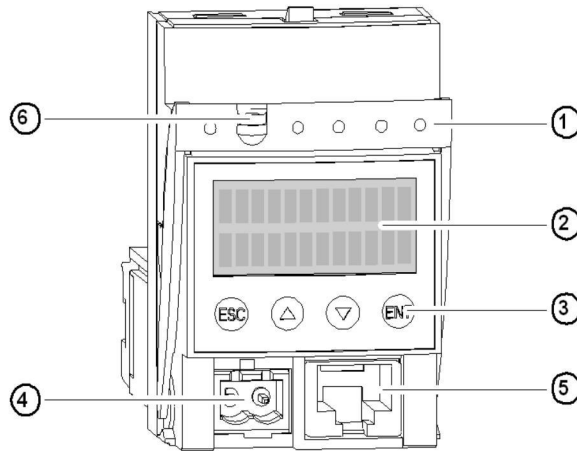

- 1 Locking and removal handle
- 2 Built-in LCD display (2 lines/12 characters)
- 3 4-key keypad
- 4 24V auxiliary power supply  (sealed connector on LUCMT)
- 5 RJ-45 communication port, Modbus RS 485
- 6 Option to seal the locking handle

RS 485 Serial Communication Port

The RS 485 serial communication port, on the front panel, may be used to connect:

- A PC with the PowerSuite software (VW3A8104)
- A pocket PC with the PowerSuite software (VW3A8104)
- An RJ-45 communication port, Modbus RS 485
- An XBT NU 400 communication terminal mounted on a cabinet door

Display and Keypad

The built-in display and keypad are used as follows:

In "Run" mode	To display the value of one or more previously selected parameters If no key is pressed for 5 seconds, the display stops scrolling
In "Off" mode (LUCM••BL)	To display the status of the motor-starter (with external 24 V DC power supply)

The multifunction control unit has a 2-line display and a 4-key keypad allowing users to navigate through programs, sub-programs, functions, and parameters or settings.

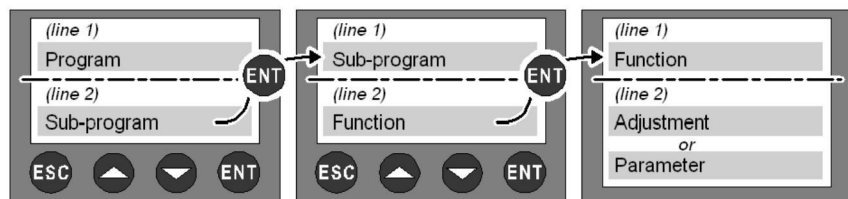

Navigation in Programs

Function of the 4 keys on the keypad:

	Move up one level in the menu. The ESC key does not save any settings.	You must press this key several times to return to the program.
	Browse in: - a program => sub-programs - a sub-program => functions - a function => settings	Some sub-programs include only functions and their settings. Others include functions with several parameters and their settings.
	Browse available settings.	The "=" sign precedes a factory setting or a user-defined setting. The "?" sign precedes available settings.
	1 Move down one level in the program. 2 Confirm and save the displayed setting.	Once you have saved the setting: <ul style="list-style-type: none"> The "?" sign is replaced by "=". The setting is displayed for 2 seconds, then the display returns automatically to the next highest level.

Examples of navigation:

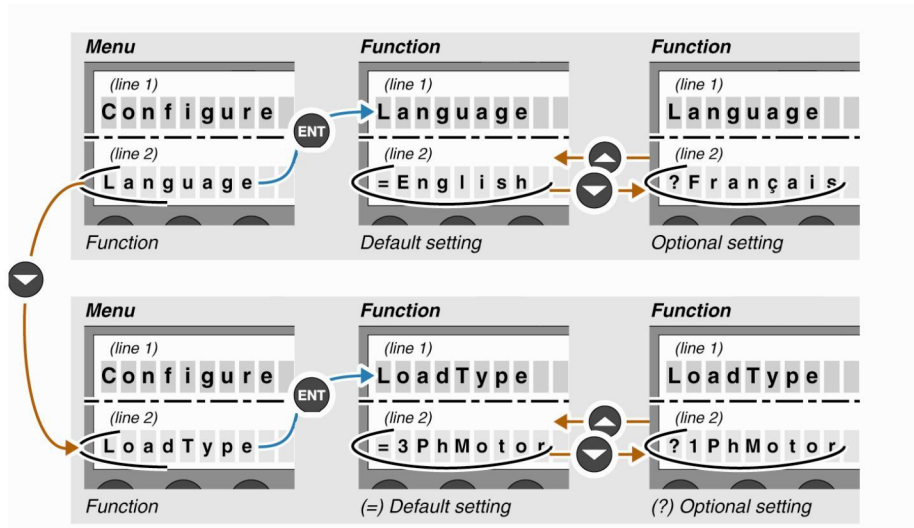

Installation and service temperature

Installation

Once installed in the base, the multifunction control unit locks the module. The multifunction control unit must be installed before installing or uninstalling a module.

Installation in a power base:

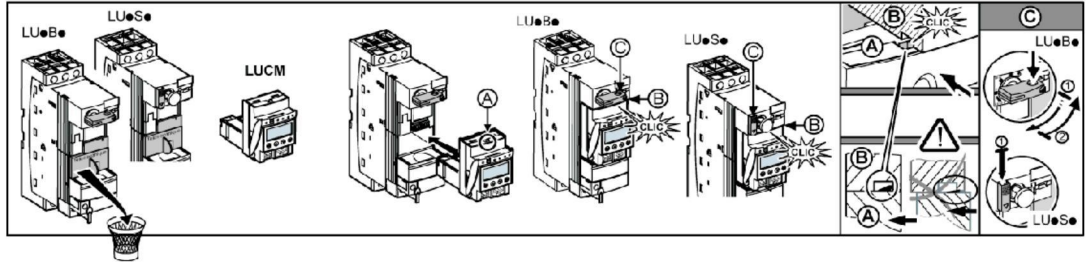

Installation in a controller base:

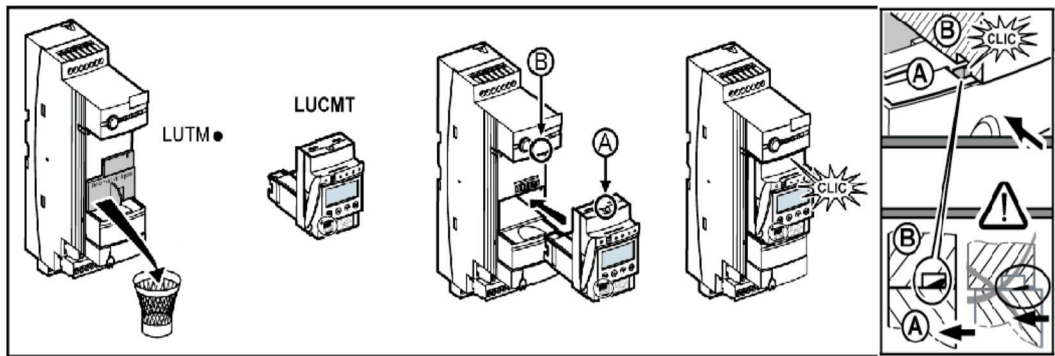

Service temperature

The multifunction control unit has internal temperature monitoring functions that cannot be disabled.

		<p>The warning message "Warn-IntTmp" appears as soon as the internal temperature exceeds 80° C.</p> <p>At 90° C, the multifunction control unit triggers the starter and the message "Internet Trip" is displayed.</p> <p>(see <i>Warning Management</i>, page 66)</p> <p>The value of the internal temperature is stored in register 472. It may be monitored via the RS 485 communication port:</p> <ul style="list-style-type: none"> locally using the PowerSuite program, remotely via the Modbus link. 	
LUTM•	LU•B•	LU•B• and LU•S•	
Distance to be maintained	Ambient temperature	Distances to be maintained	Ambient temperature
d = 0 mm (0 in.)	65° C (149° F)	d = 0 mm (0 in.)	45° C (113° F)
		d ≥ 9 mm (0.35 in.)	55° C (131° F)
		d ≥ 20 mm (0.75 in.)	60° C (140° F)

Connection

Connecting the LUCM

The LUCM multifunction control unit has two 24 V DC power supplies:

- **The supply for the control circuit**, accessible only via the A1/A2 terminals on the power base
- **The auxiliary power supply**, on its front panel.

WARNING

LOSS OF POWER IN EVENT OF POWER CUT

The devices that cut the power must be connected to terminal A1 (+) on the control circuit.

Failure to follow these instructions can result in death, serious injury, or equipment damage.

NOTE: Powering off then powering on the control circuit by terminals A1/A2, without the auxiliary power supply, resets the parameters of the **48_Jam** function (message: Off-Jam) by authorizing the closing of the power poles (see *Internal or External Environment-related Faults, page 69*).

The auxiliary power supply is used for the following operations:

- Initial configuration and adjustment before installing the power base or before connecting the power supply of the control circuit to the A1/A2 terminals
- Remote and automatic reset functions with a 3-wire control
- Changes to settings during "Off" or "LastTrip" modes
- Display of fault types or statistics during "Off" or "LastTrip" modes
- Communication with the multifunction control unit during "Off" or "LastTrip" modes
- Use of a function module (communication or application)

NOTE: Input A2 of the control circuit is internally connected to the (-) input terminal of the auxiliary power supply. If the polarity of the A1/A2 terminals is inverted, the multifunction control unit triggers an internal fault #62 (see *Fault Acknowledgement, page 70*) to acknowledge the fault.

Connecting the LUCMT

The LUCMT multifunction control unit has only one 24 V DC power supply that is directly connected to the 24 V DC power supply of the LUTM•• controller base.

The power supply of the controller base is required for configuration and adjustments.

NOTE: Powering off then powering on this 24 V DC power supply resets the parameters of the **48_Jam** function (message: Off-Jam, see *Motor Safety Protection Faults, page 68*).

Quick start

2

Use the Quick start section if you are already familiar with the product. Otherwise, see the detailed start procedure.

What's in this Chapter?

This chapter contains the following topics:

Topic	Page
Actions for quick set-up	18
Default Settings and Optional Values of the LUCM	20
Default Settings and Optional Values of the LUCMT	23

Actions for quick set-up

At a Glance

A quick set-up of the multifunction control unit implies action on:

- the electrical supply,
- the configuration.

Electrical supply

The electrical supply varies according to the type of control unit.

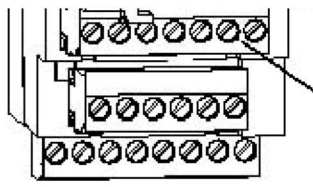
LUCM	<p>Connect the auxiliary power supply (24 VDC) of the multifunction control unit. ==> <i>The control unit may be inside or outside the Power base.</i></p>	
LUCMT	<p>Supply of the LUTM•• Controller base (24 VDC) ==> <i>The multifunction control unit must be installed in the LUTM•• Controller base</i></p>	

Configuration during commissioning

Configure the multifunction control unit via the following steps:

Step	Action	Display	
1	Press the ENT key to start the configuration. The first function of the Config Menu program is displayed.	Config Menu	
		...	ENT
		Config Menu	
		Language	ENT
2	Enter the functions that define the profile of the multifunction control unit. The functions vary according to the Base: - LUCM••BL: Language, LoadType, Base, AuxFan - LUCMT1BL: Language, AuxFan, CT_Ratio	Language	
		= English	▼
		Language	
		? Français	ENT
		
3	Display the End Config function. Confirm the configuration (? Yes) via the ENT key, to access the Main Menu program.	Config Menu	
		End Config	ENT
		End Config	
		= No	▼
4	In the Main Menu program, use the (down arrow) key to scroll the sub-programs until 3_Setup . Press the ENT key to enter the setup.	? Yes	ENT
		Main Menu	
		1_Reference	▼
		Main Menu	
5	Press the ENT key to access the parameters of the 31_FLASet function.	3_Setup	
		31_FLASet	ENT
		3_Setup	
6	The value displayed corresponds to the control unit installed (e.g. LUCM05BL). Use the (up arrow) key to select the value of the nominal current at full load corresponding to the reference of the installed product.	31_FLASet	
		= 1.25 A	▲
		31_FLASet	
		? 2.00 A	

Default Settings and Optional Values of the LUCM

Programs, sub-programs and functions of the LUCM multifunction control unit:

Program	Sub-prog.	Function	Parameter	Factory setting or profile	Optional values
Config Menu	-	Language	-	= English	? Français ? Español ? Deutsch ? Italiano
		LoadType	-	= 3 PhMotor	? 1 PhMotor
		Base	-	= SelfProtStr	? Starter
		AuxFan	-	= No	? Yes
		LR Conf <i>(from versions V3.x onwards)</i>	-	= Remote	? Local
		End Config	-	= No	? Yes
Main Menu	1_Reference	11_Catalog <i>(see 31_FLASet for LUCM, page 41).</i>	-	LUCMX6BL	According to the reference of the multifunction control unit
		12_Firmware	-	Rev: xx.xx	
		13_FLARange <i>(see 31_FLASet for LUCM, page 41).</i>	-	0.15 A to 0.6 A (Min to Max)	
		14_LoadType	-	= 3 PhMotor	
		15_AuxFan	-	= No	
		16_Base	-	= SelfProtStr	
	2_Display	21_AvCurrent	-	= Yes	(read only) configured in Config Menu
		22_ThermCap	-	= No	? Yes
		23_L1Current	-	= No	? Yes
		24_L2Current	-	= No	? Yes
		25_L3Current	-	= No	? Yes
		26_GFCCurrent	-	= No	? Yes
		27_LastTrip	-	= No	? Yes
		28_PhaseImb	-	= No	? Yes

Program	Sub-prog.	Function	Parameter	Factory setting or profile	Optional values
Main Menu	3_Setup	31_FLASet According to the reference of the multifunction control unit	LUCMX6BL	= 0.15 A	? 0.15 to 0.6
			LUCM1XBL	= 0.35 A	? 0.35 to 1.4
			LUCM05BL	= 1.25 A	? 1.25 to 5
			LUCM12BL	= 3 A	? 3 to 12
			LUCM18BL	= 4.5 A	? 4.5 to 18
			LUCM32BL	= 8 A	? 8 to 32
		32_TestTrip	-	= No	? Yes
	33_Pause (version V1.x only)	-	= No	? Yes	
	34_Language	-	= English	? Français ? Español ? Deutsch ? Italiano	
	4_AdvSetup	41_TripClass	-	= 5	? 5 to 30
		42_ResetMode	-	= Manual	? Remote/Ent ? Auto
		43_RstAdjust	ResetTime	= 120 s	? 1 to 1000
			ResetLevel	= 80% (Capacity)	? 35 to 95
		44_MagTrip	-	= 1420% FLA	? 300 to 1700
		45_OLWarning	Warning	= On	? Off
			Warn Level	= 85% (Capacity)	? 10 to 100
		46_GroundFlt	Trip	= On	? Off
			TripTime	= 1.0 s	? 0.1 to 1.2
			TripLevel	= x A (30% FLA min)	? 20 to 500
			Warning	= On	? Off
			Warn Level	= x A (30% FLA min)	? 20 to 500
		47_PhaseImb	Trip	= On	? Off
			TripTimeStrt	= 0.7 s	? 0.2 to 20
TripTimeRun			= 5	? 0.2 to 20	
TripLevel			= 10% IMB	? 10 to 30	
Warning	= On		? Off		
Warn Level	= 10% IMB		? 10 to 30		

Program	Sub-prog.	Function	Parameter	Factory setting or profile	Optional values
Main Menu	4_AdvSetup	48_Jam	Trip	= On	? Off
			TripTime	= 5 s	? 1 to 30
			TripLevel	= 200% FLA	? 100 to 800
			Warning	= On	? Off
			Warn Level	= 200% FLA	? 100 to 800
		49_UndrLd	Trip	= On	? Off
			TripTime	= 10 s	? 1 to 200
			TripLevel	= 50% FLA	? 30 to 100
			Warning	= On	? Off
			Warn Level	= 50% FLA	? 30 to 100
		410_LongStrt	Trip	= On	? Off
			TripTime	= 10 s	? 1 to 200
			TripLevel	= 100% FLA	? 100 to 800
			Warning	= On	? Off
			Warn Level	= 100% FLA	? 100 to 800
	5_CommSetup	51_Drop	-	= 1	? 1 to 247
		52_Baud	-	= 19200 bps	? 1200 to 19200
		53_Parity	-	= Even	? None
		54_Control	-	= On	? Off
		55_CommLoss	-	= Ignore	? Dropout ? Trip ? Warning
	6_Module	61_ID Clear	-	= Yes	? No
		62_Reference	Module	ID = 0	-
			Catalog	? (if ID = 0)	-
			Firmware	Rev: 0.00 (if ID = 0)	-
		63_ID Set	-	= 0	0 to 149
64_Param dec		Parameter 1-10	= 00000	00000 to 65535	
65_Param hex	Parameter 1-10	= 0000	0000 to FFFF		
Main Menu	7_Statistics	71_Trip0	-	In case of a return to factory settings, the statistical data is erased (see <i>Sub-program 7_Statistics, page 58</i>).	
		72_Trip1	-		
		73_Trip2	-		
		74_Trip3	-		
		75_Trip4	-		
		76_Totals	-		
	8_Password	81_Unlock	-	Passwd?	0000 - 9999
		82_Lock	-	New PSW?	0000 - 9999
		83_Rst Stats	-	= No	? Yes
		84_RstToDfts	-	= No	? Yes

Default Settings and Optional Values of the LUCMT

Programs, sub-programs and functions of the LUCMT multifunction control unit:

Program	Sub-prog.	Function	Parameter	Factory setting or profile	Optional values
Config Menu	-	Language	-	= English	? Français ? Español* ? Deutsch* ? Italiano* (* version V3.2 onwards)
		AuxFan	-	= No	? Yes
		CT_Ratio <i>(no parameter with factory settings)</i> One of the 9 parameters must be confirmed before you can exit the Config Menu	? 30:3	= No	? Yes (3.5 - 10.5 A)
			? 30:2	= No	? Yes (5.2 - 15.7 A)
			? 30:1	= No	? Yes (10.5 - 31.5 A)
			? 50:1	= No	? Yes (17.5 - 52.5 A)
			? 100:1	= No	? Yes (35 - 105 A)
			? 200:1	= No	? Yes (70 - 210 A)
			? 400:1	= No	? Yes (140 - 420 A)
			? 800:1	= No	? Yes (280 - 840 A)
? Others	Parameters: Primary Secondary Exter_Pass	1 to 65535 1 to 500 1 to 100			
LR Conf <i>(from versions V3.x onwards)</i>	-	= Remote	? Local		
End Config	-	= No	? Yes		
Main Menu	1_Reference	11_Catalog <i>(see 31_FLASet for LUCM, page 41).</i>	-	LUCMT1BL	
		12_Firmware	-	Rev: xx.xx	
		13_FLA Range <i>(see 31_FLASet for LUCM, page 41).</i>	-	According to CT_Ratio (Min to Max)	
		15_AuxFan (read only)	-	= No	Configured in Config Menu

Program	Sub-prog.	Function	Parameter	Factory setting or profile	Optional values
Main Menu	2_Display	21_AvCurrent	-	= Yes	? No
		22_ThermCap	-	= No	? Yes
		23_L1Current	-	= No	? Yes
		24_L2Current	-	= No	? Yes
		25_L3Current	-	= No	? Yes
		26_GFCCurrent	-	= No	? Yes
		27_LastTrip	-	= No	? Yes
		28_PhaseImb	-	= No	? Yes
		29_ONhours	-	= No	? Yes
	3_Setup	31_FLASet	LUCMT1BL	= x A (CT_Ratio)	? x.xx to x.xx A
		32_TestTrip	-	= No	? Yes
		34_Language	-	= English	? Français ? Español* ? Deutsch* ? Italiano* (* version V3.2 onwards)
	4_AdvSetup	41_TripClass	-	= 5	? 5 to 30
		42_ResetMode	-	= Manual	? Remote/Ent ? Auto
		43_RstAdjust	ResetTime	= 120 s	? 1 to 1000
			ResetLevel	= 80% (Capacity)	? 35 to 95
		45_OLWarning	Warning	= On	? Off
			Warn Level	= 85% (Capacity)	? 10 to 100
		46_GroundFlt	Trip	= On	? Off
			TripTime	= 1.0 s	? 0.1 to 1.2
			TripLevel	= x A (30% FLA min)	? 20 to 500
			Warning	= On	? Off
			Warn Level	= x A (30% FLA min)	? 20 to 500
		47_PhaseImb	Trip	= On	? Off
			TripTimeStrt	= 0.7 s	? 0.2 to 20
			TripTimeRun	= 5	? 0.2 to 20
			TripLevel	= 10% IMB	? 10 to 30
	Warning		= On	? Off	
	Warn Level		= 10% IMB	? 10 to 30	

Program	Sub-prog.	Function	Parameter	Factory setting or profile	Optional values
Main Menu	4_AdvSetup	48_Jam	Trip	= On	? Off
			TripTime	= 5 s	? 1 to 30
			TripLevel	= 200% FLA	? 100 to 800
			Warning	= On	? Off
			Warn Level	= 200% FLA	? 100 to 800
		49_UndrLd	Trip	= On	? Off
			TripTime	= 10 s	? 1 to 200
			TripLevel	= 50% FLA	? 30 to 100
			Warning	= On	? Off
			Warn Level	= 50% FLA	? 30 to 100
		410_LongStrt	Trip	= On	? Off
			TripTime	= 10 s	? 1 to 200
			TripLevel	= 100% FLA	? 100 to 800
			Warning	= On	? Off
			Warn Level	= 100% FLA	? 100 to 800
	5_CommSetu P	51_Drop	-	= 1	? 1 to 247
		52_Baud	-	= 19200 bps	? 1200 to 19200
		53_Parity	-	= Even	? None
		54_Control	-	= On	? Off
		55_CommLoss	-	= Ignore	? Dropout ? Trip ? Warning
	6_Module	61_ID Clear	-	= Yes	? No
		62_Reference	Module	ID = 0	-
			Catalog	? (if ID = 0)	-
			Firmware	Rev: 0.00 (if ID = 0)	-
		63_ID Set	-	= 0	0 to 255
64_Param dec		Parameter 1-10	= 00000	00000 to 65535	
65_Param hex	Parameter 1-10	= 0000	0000 to FFFF		
Main Menu	7_Statistics	71_Trip0	-	In case of a return to factory settings, the statistical data is erased (see <i>Sub-program 7_Statistics, page 58</i>).	
		72_Trip1	-		
		73_Trip2	-		
		74_Trip3	-		
		75_Trip4	-		
		76_Totals	-		
	8_Password	81_Unlock	-	Passwd?	0000 - 9999
		82_Lock	-	New PSW?	0000 - 9999
		83_Rst Stats	-	= No	? Yes
		84_RstToDfts	-	= No	? Yes

Detailed Startup and Adjustments During Use

3

This chapter presents the detailed startup of the LUCM and LUCMT, as well as the adjustments that can be made when using the product.

WARNING

RISK OF UNINTENDED OPERATION

This device must be installed, configured, and used by qualified personnel only.

Users must follow the recommendations, standards, and regulations in force.

Check the function settings before starting the motor.

Do not damage or modify the device.

Failure to follow these instructions can result in death, serious injury, or equipment damage.

What's in this Chapter?

This chapter contains the following topics:

Topic	Page
Organization of the interface	28
Power up and operating modes	31
'Config Menu' Program	33
'Main Menu' program	38
1_Reference sub-program	39
Sub-Program 2_Display	40
Sub-Program 3_Setup	41
Sub-program 4_AdvSetup	45
Sub-program 5_CommSetup	54
Sub-program 6_Module	56
Sub-program 7_Statistics	58
Sub-program 8_Password	60
Start-up Phase	62

Organization of the interface

'Config Menu' and 'Main Menu' programs

The interface comprises 2 programs: **Config Menu** and **Main Menu**.

You access the **Config Menu** program:

- either during the commissioning,
- or from the Main Menu program, by performing a reset using the 84_RstToDfts function.

The **Config Menu** program of an LUCM is different from that of an LUCMT.

'Config Menu' program for LUCM

This program includes the configuration settings for an LUCM multifunction control unit:

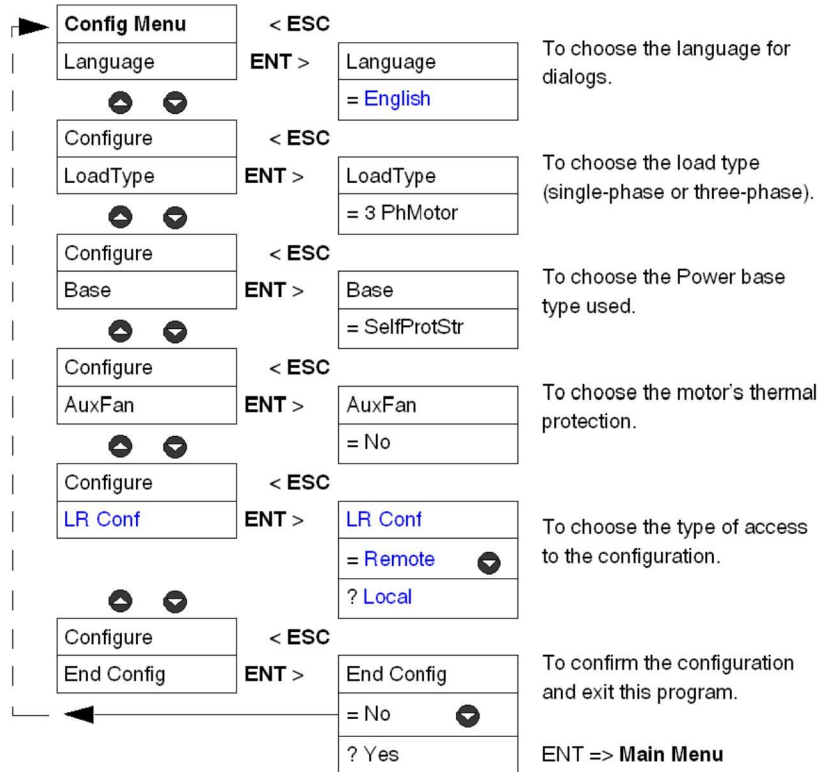

'Config Menu' program for LUCMT

This program includes the configuration settings for an LUCMT multifunction control unit:

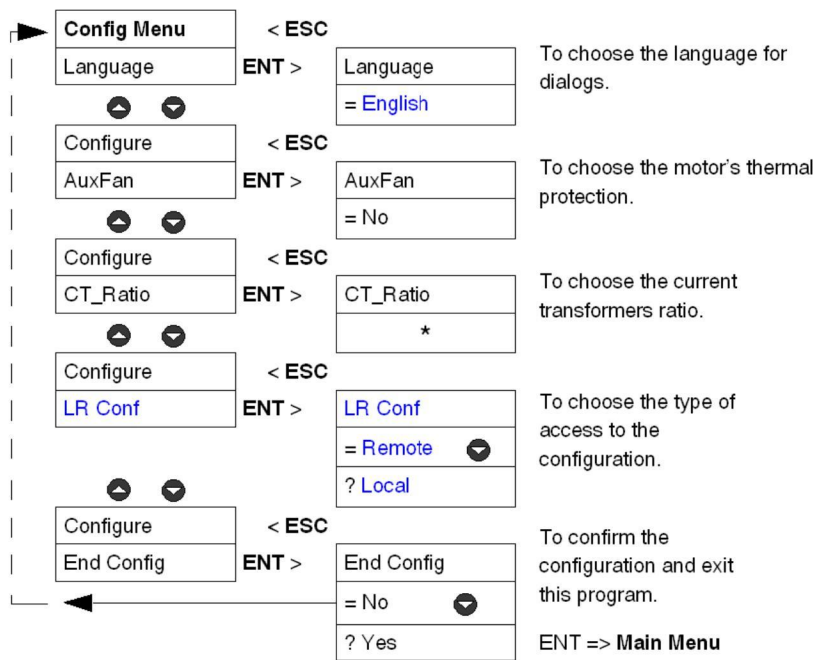

* No transformation ratio is saved in the factory settings. This parameter must be entered before you can exit the **Config Menu** program.

'Main Menu' program

This program includes the application settings and the parameters that can be modified.

The ESC key does not allow a return to the **Config Menu** program. To do so, you must confirm the **84_RstToDfts** function in order to cancel the existing configuration.

Main menu	< ESC		
1_Reference	ENT >	1_Reference	To view the configuration data.
▲ ▼		11_Catalog	
Main menu	< ESC		
2_Display	ENT >	2_Display	To choose the settings to display in "Run" mode.
▲ ▼		21_AvCurrent	
Main menu	< ESC		
3_Setup	ENT >	3_Setup	To adjust the basic parameters.
▲ ▼		31_FLASet	
Main menu	< ESC		
4_AdvSetup	ENT >	4_AdvSetup	To configure the protection functions and the associated warnings.
▲ ▼		41_TripClass	
Main menu	< ESC		
5_CommSetup	ENT >	5_CommSetup	To configure the Modbus RS 485 communication port.
▲ ▼		51_Drop	
Main menu	< ESC		
6_Module	ENT >	6_Module	To configure the function module.
▲ ▼		61_ID Clear	
Main menu	< ESC		
7_Statistics	ENT >	7_Statistics	To view the statistics on the "LastTrip" and "Run" information.
▲ ▼		71_Trip0	
Main menu	< ESC		
8_Password	ENT >	8_Password	To activate the password or reset the parameters and statistics.
		81_Unlock	

Power up and operating modes

The operating modes depend on the system status:

Start-up phase	Initial power up	"Configuration" mode (LUCM and LUCMT)
	Next power-ups	"Pause" mode (LUCM) "Off" mode (LUCM) "Ready" mode (LUCMT)
After the start-up phase		"Run" mode (LUCM and LUCMT)

Initial power up

The first time the multifunction control unit is powered up, after leaving the factory, it is in "Configuration" mode. The interface automatically displays the "**Config Menu**" program:

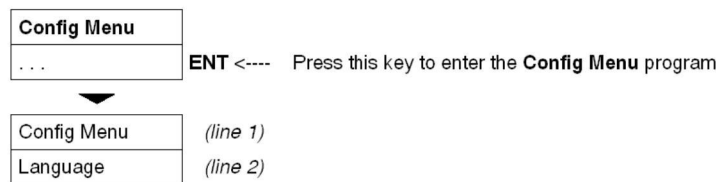

- The LUCM multifunction control unit must be configured before authorizing the power poles to be closed.

NOTE: If the configuration is done with the control circuit power supply only (A1/A2), the multifunction control unit switches to "**Pause**" mode as soon as the **End Config** function is confirmed. The power poles may be closed by deactivating the **33_Pause** function.

- The LUCMT multifunction control unit must be configured before authorizing the output relays (13 and 23) to be closed.

Subsequent power ups

During subsequent power ups, the LUCM multifunction control unit is in the following mode:

- "**Pause**", or
- "**Off**".

During subsequent power ups, the LUCMT multifunction control unit is in the following mode:

- "**Ready**".

The **Main Menu** program is accessible from these three modes:

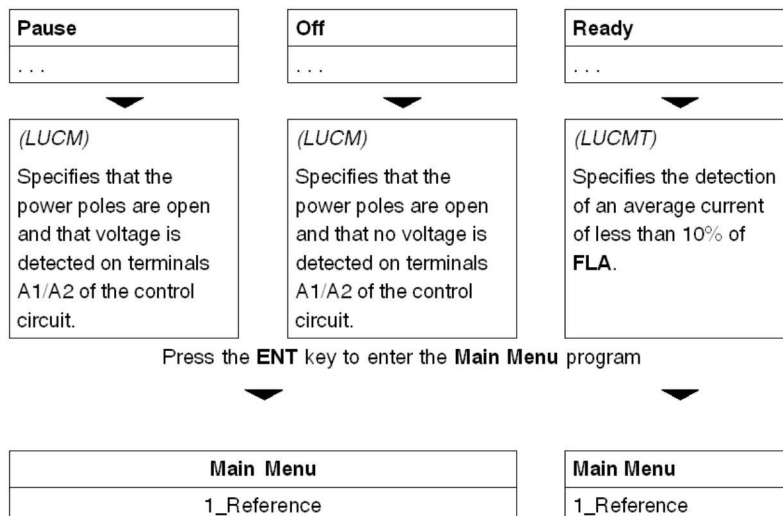

All the settings of the **Main Menu** program may be changed in those modes, except for the following functions: **1_Reference** and **7_Statistics** (read only).

"Run" mode

The **"Run"** mode occurs after the start-up phase:

Line 1 displays "Start" , indicating that the motor is in start-up phase (see <i>Start-up Phase, page 62</i>). <ul style="list-style-type: none"> • (LUCM) when the power poles are closed, • (LUCMT) when the average current detected is greater than 10% of FLA. Line 2 displays the average current (IAV).	Start
	IAV = 2.5 A
Once the start-up phase has completed (maximum 10 sec.). "Run" is displayed on line 1, indicating the start of Run mode. Line 2 displays a loop of the information to be monitored. <ul style="list-style-type: none"> • (by default) value of the average current - IAV (21_AvCurrent), • or another parameter (to be selected, see <i>2_Display for LUCM, page 40</i>), 	Run
	IAV = 2.5 A
Press the ENT key to access the Main Menu program.	Main Menu
	1_Reference

When the multifunction control unit is in **"Run"** mode, only the **2_Display** and **3_Setup** functions can be modified.

Once in the Main Menu program, if no key is pressed during a 30 second period, the system returns to the current mode ("Run" , "Pause" , "Off" , "Ready").	Run
	IAV = 2.5 A

'Config Menu' Program

Introduction to the 'Config Menu' Program

This program lets you configure your multifunction control unit, according to the connected device.

- **Config Menu** appears on the first line of the display.
- The current function is displayed on the second line of the display.

Before accessing the **Main Menu** program, you must configure the multifunction control unit and confirm the configuration (**End Config** function). Then the configuration settings may be viewed at any time in the **1_Reference** function of the **Main Menu** program.

NOTE: To edit the parameters after you have confirmed the configuration (**End Config** function), you must return the multifunction control unit to the default configuration (see *84_RstToDfts*, page 61).

Configure an LUCM

Functions to be configured for an LUCM:



Main Menu (line 1)	Function (line 2)	Comments
Config Menu	Language	To choose the language for dialogs. Option to edit this choice in the 34_Language function.
	LoadType	To define whether a three-phase or single-phase motor is used. <i>Choosing '1 phase' for a motor with a three-phase power supply will cause an internal fault #60, meaning that a value was detected on IL2.</i>
	Base	To specify the type of Power base (marked on one of its sides) where the multifunction control unit is installed.
	AuxFan	To define the thermal protection for motors cooled by an auxiliary fan. If it is activated, this parameter reduces the time before reset by 75%. <i>(see Thermal trigger and reset graphs, page 72).</i>
	LR Conf	To select the type of access to the configuration of the multifunction control unit.
	End Config	To save the configuration and access the Main Menu .

LUCM functions: Language, LoadType, Base, AuxFan, LRConf

Dialog **language** for an LUCM:

Language	 	= English	Dialogs in English (default)
		? Français	Dialogs in French
		? Español	Dialogs in Spanish
		? Deutsch	Dialogs in German
		? Italiano	Dialogs in Italian



Type of **load** for an LUCM:

LoadType	 	= 3 PhMotor	Protection of a three-phase motor (default)
		? 1 PhMotor	Protection of a single-phase motor

This parameter impacts the calculation of the average current value:

- If three-phase motor ==> $AvCurrent = (I1 + I2 + I3) / 3$
- If single-phase motor ==> $AvCurrent = (I1 + I3) / 2$

Type of **Base** for an LUCM:

Define the base as a Power base (Starter-controller or Starter):			
Base	 	= SelfProtStr	Starter-controller including protection against short-circuits and thermal overloads (default).
		? Starter	Starter including protection against thermal overloads only. In this case, the installer should associate the Starter Power base with a device for protecting against short-circuits.

⚠ CAUTION



INCORRECT CONFIGURATION OF THE "BASE" FUNCTION.

This function is used for identification only. It does not impact the protection functions, adjustments, or the protection type provided by the Power base.

An incorrect configuration may cause an incorrect display or an incorrect read by the bus.

Failure to follow these instructions can result in injury or equipment damage.

Aux. fan motor for an LUCM: thermal protection characteristics required for protecting a motor.

AuxFan	 	= No	- self-cooled motor (default) (not cooled by an auxiliary fan)
		? Yes	- motor with auxiliary fan (cooled by an auxiliary fan)

⚠ CAUTION



INCORRECT CONFIGURATION OF THE "AUXFAN" FUNCTION.

If it is activated, this parameter reduces the time before reset by 75%.



If the motor is not cooled by an auxiliary fan, the value of the thermal capacity will be incorrect.

Failure to follow these instructions can result in injury or equipment damage.

Choice of the type of **access** to the configuration of an LUCM:

LR Conf	 	= Remote	- the configuration can be downloaded via the associated communication module (except Modbus)
		? Local	- the configuration can only be entered via the keypad on the product

End of configuration mode for an LUCM:

End Config	 	= No	ENT or ESC => stay on End Config
		? Yes	ENT => save the configuration and return to Off ESC => stay on End Config

Configure an LUCMT

Functions to be configured for an LUCMT:

Program (line 1)	Function (line 2)	Comments
Config Menu	Language	To choose the language for dialogs. Option to edit this choice in the 34_Language function.
	AuxFan	To define the thermal protection for motors cooled by an auxiliary fan. If this parameter is activated, it reduces the time before reset by 75%. (see <i>Thermal trigger and reset graphs, page 72</i>).
	CT_Ratio	To set the transformation ratio in Amperes for adjusting protections and the display. The CT_Ratio depends on the current (intensity) transformers used. CT_Ratio must be configured before you can exit the Config Menu program.
	LR Conf	To select the type of access to the configuration of the multifunction control unit.
	End Config	To save the configuration and access the Main Menu program.

LUCMT functions: Language, AuxFan, CT_Ratio, LRConf

Dialog **language** for an LUCMT:

Language	= English	Dialogs in English (default)
	? Français	Dialogs in French
	? Español*	Dialogs in Spanish
	? Deutsch*	Dialogs in German
	? Italiano*	Dialogs in Italian

(* version V3.2 onwards)

Aux. fan motor for an LUCMT: the thermal protection characteristics are those required for protecting a motor.

AuxFan	= No	- self-cooled motor (default) (not cooled by an auxiliary fan)
	? Yes	- motor with auxiliary fan (cooled by an auxiliary fan)

CAUTION

INCORRECT CONFIGURATION OF THE "AUXFAN" FUNCTION.

If it is activated, this parameter reduces the time before reset by 75%.

If the motor is not cooled by an auxiliary fan, the value of the thermal capacity will be incorrect.

Failure to follow these instructions can result in injury or equipment damage.

Transformation ratio of the **CT_Ratio** current for an LUCMT:

CT_Ratio	No factory-set value ==> the parameter must be defined in this function (primary voltage/secondary voltage) (see 31_FLASet for LUCM, page 41)	
	30:3	30:3 current transformers
	30:2	30:2 current transformers
	30:1	30:1 current transformers
	50:1	50:1 current transformers
	100:1	100:1 current transformers
	200:1	200:1 current transformers
	400:1	400:1 current transformers
	800:1	800:1 current transformers
	Others	To enter transformer characteristics different from those above: - primary (Primary), - secondary (Secondary) - number of passes (Exter_Pass)

30:3		= No	(default) Return to parameter selection
		? Yes	For a CT_Ratio of 30:3, the range of threshold current settings will be from 3.5 - 10.5 A

30:2		= No	(default) Return to parameter selection
		? Yes	For a CT_Ratio of 30:2, the range of threshold current settings will be from 5.2 - 15.7 A

30:1		= No	(default) Return to parameter selection
		? Yes	For a CT_Ratio of 30:1, the range of threshold current settings will be from 10.5 - 31.5 A

50:1		= No	(default) Return to parameter selection
		? Yes	For a CT_Ratio of 50:1, the range of threshold current settings will be from 17.5 - 52.5 A

100:1		= No	(default) Return to parameter selection
		? Yes	For a CT_Ratio of 100:1, the range of threshold current settings will be from 35 - 105 A





200:1		= No	(default) Return to parameter selection
		? Yes	For a CT_Ratio of 200:1, the range of threshold current settings will be from 35 - 105 A

400:1		= No	(default) Return to parameter selection
		? Yes	For a CT_Ratio of 400:1, the range of threshold current settings will be from 140 - 420 A

800:1		= No	(default) Return to parameter selection
		? Yes	For a CT_Ratio of 800:1, the range of threshold current settings will be from 280 - 840 A

For information about setting ranges for an LUCMT, refer to 31_FLASet for LUCM, page 41.

CT_Ratio Others (other current transformation ratios). Set the following 3 sub-programs:

Others (line 1)	Adjustment (line 2)	Comments
Primary (Primary circuit characteristic)	= 00000	To configure the value of the primary current. Settings range from 1 to 65535. By default, the value indicated on the left is 0. Press ENT to start the adjustment. Adjust the five figures individually using the up and down arrows, starting from the furthest to the left. Confirm each figure by pressing ENT before going on to the next. When you have confirmed everything, the number is displayed on the left after the "=" sign. To exit, press ESC .
	= 00000 5_ _ _ _ _ ENT	Example of setting the Primary parameter to 53214:
	= 50000 _ 3 _ _ _ _ ENT	
	= 53000 _ _ 2 _ _ ENT	
	= 53200 _ _ _ 1 _ ENT	
	= 53210 _ _ _ _ 4 ENT	
	= 53214	
Secondary (Secondary circuit characteristic)	= 1	To configure the value of the secondary current. Settings range from 1 (default) to 500, in increments of 1. Press ENT to start the adjustment. Press  or  to increase or decrease the value displayed. Press ENT to confirm the value.
Exter_Pass	= 1	To specify the number of passes made in the primary of the current transformer. Settings range from 1 (default) to 100, in increments of 1. Press ENT to start the adjustment. Press  or  to increase or decrease the value displayed. Press ENT to confirm the value.

Example: Manual entry or modification of a transformation ratio of 160:1

Primary (Primary circuit characteristic) = 800



Secondary (Secondary circuit characteristic) = 1

Exter_Pass = 5



$800 / (1 * 5) = 160.$

⚠ CAUTION
<p>INCORRECT CONFIGURATION OF THE "CT_RATIO" FUNCTION.</p> <p>The CT_Ratio must be specified to make the product compatible with the current transformers used. The CT_Ratio specifies the default values of the FLA and the various protections of the motor being monitored.</p> <p>Failure to follow these instructions can result in injury or equipment damage.</p>

Choice of the type of **access** to the configuration of an LUCMT:

LR Conf	 	= Remote	- the configuration can be downloaded via the associated communication module (except Modbus)
		? Local	- the configuration can only be entered via the keypad on the product

End of configuration mode for an LUCMT:

End Config	 	= No	ENT or ESC => stay on End Config
		? Yes	ENT => save the configuration and return to Ready ESC => stay on End Config

'Main Menu' program

Introduction to the 'Main Menu' program

After having configured the multifunction control unit, the display shows:

- **Off** (for an LUCM)
- **Ready** (for an LUCMT).

Press **ENT** to access the **Main Menu** program:

line 1	Main Menu
line 2	1_Referenc e

The **Main Menu** program contains all the sub-programs required by users to:

- configure the values and statuses to be displayed,
- configure the protection functions,
- configure the module's input/output and communications,
- access the data stored in the statistics.

If no action is taken for 30 seconds, the display returns to:

- **Off** (for an LUCM)
- **Ready** (for an LUCMT).

Functions of the 'Main Menu' program

The **Main Menu** program displays the following sub-programs:

Program (line 1)	Sub-prog. (line 2)	Comments
Main Menu	1_Reference	To display the reference of the multifunction control unit and the choices made in the Config Menu .
	2_Display	To define the values and statuses to display on the control unit display in " Run " mode.
	3_Setup	To access all the base settings, which can be changed in " Run " mode.
	4_AdvSetup	To access the settings of protection functions and the associated warnings.
	5_CommSetup	To access the settings of the RS 485 communication port.
	6_Module	To access the communications settings with the function module, which can be modified in " Run " mode.
	7_Statistics	To access the statistics of information saved in the multifunction control unit memory. It includes the history of triggers, and the trigger and stop counters.
	8_Password	To set up a password preventing untimely changes to modifiable functions. To also access the function to reset the multifunction control unit.

Each sub-program, from 1_Reference to 8_Password, is described in detail in the following chapters.

1_Reference sub-program

At a Glance

The **1_Reference** sub-program allows only to read the references and choices made in the **Config Menu** program.

This information can be **viewed** in all modes. The LUCM reference is different from the LUCMT reference.

1_Reference for LUCM

Main Menu is displayed on the first line of the display.

1_Reference is displayed on the second line of the display.

Press **ENT** to display the reference of the configuration (**read only**).

Sub-prog. (lines 1 and 2)	Function Reference (lines 1 and 2)	Comments
1_Reference	11_Catalog LUCMX6BL	Manufacturing no. (line 2).
	12_Firmware Rev: xx.xx	Firmware revision number (line 2).
	13_FLA Range 0.15 - 0.6 A	Range of threshold current settings (min. - max.) (line 2).
	14_LoadType = 3 PhMotor	Type of load (line 2). (result of the choice made in Config Menu)
	15_AuxFan = No	Type of cooling for the motor (line 2). (result of the choice made in Config Menu)
	16_Base = SelfProtStr	Type of Base (line 2). (result of the choice made in Config Menu)

1_Reference for LUCMT

Main Menu is displayed on the first line of the display.

1_Reference is displayed on the second line of the display.

Press **ENT** to display the reference of the configuration (**read only**).

Submenu (lines 1 and 2)	Function Reference (lines 1 and 2)	Comments
1_Reference	11_Catalog LUCMT1BL	Manufacturing no. (line 2). <i>This value is fixed.</i>
	12_Firmware Rev: xx.xx	Firmware revision number (line 2). <i>This value is fixed.</i>
	13_FLA Range 35 - 105 A	Range of threshold current settings (min. - max.) (line 2). <i>This value depends on the CT_Ratio configured.</i>
	14_LoadType = 3 PhMotor	Type of load (line 2). <i>This value is fixed.</i>
	15_AuxFan = No	Type of cooling for the motor (line 2). (result of the choice made in Config Menu)
	16_Base = Controller	Type of Base (line 2). <i>This value is fixed.</i>

Sub-Program 2_Display

At a Glance

The sub-program **2_Display** is used to define the values and states which will appear in a loop on the screen of the control unit in "Run" mode.

Each function may be **activated/deactivated** in any mode. The display on LUCM is different than the one on LUCMT.

2_Display for LUCM

The current function is displayed on the second line of the display.

Sub-prog. (line 1)	Function (line 2)	Comments
2_Display	21_AvCurrent	The average motor current. Monophase current or the average of currents in the 3 phases (A) = Yes (default)
	22_ThermCap	The thermal capacity of the motor (%) = No (default)
	23_I L1	The L1 current measured in the L1/T1 phase (A) = No (default)
	24_I L2	The L2 current measured in the L2/T2 phase (A) = No (default)
	25_I L3	The L3 current measured in the L3/T3 phase (A) = No (default)
	26_GFCcurrent	The average ground fault current (A) = No (default)
	27_Trip	Last trip type (A) = No (default)
	28_PhaseImb	The percentage of imbalance between the phases, for three-phase loads (%) = No (default)

2_Display for LUCMT

The current function is displayed on the second line of the display.

Sub-prog. (line 1)	Function (line 2)	Comments
2_Display	21_AvCurrent	The average motor current. Monophase current or the average of currents in the 3 phases (A) = Yes (default)
	22_ThermCap	The thermal capacity of the motor (%) = No (default)
	23_I L1	The L1 current measured in the L1/T1 phase (A) = No (default)
	24_I L2	The L2 current measured in the L2/T2 phase (A) = No (default)
	25_I L3	The L3 current measured in the L3/T3 phase (A) = No (default)
	26_GFCcurrent	The average ground fault current (A) = No (default)
	27_Trip	Last trip type (A) = No (default)
	28_PhaseImb	The percentage of imbalance between the phases, for three-phase loads (%) = No (default)
	29_ONhours	The number of operating hours (h) = No (default)

Sub-Program 3_Setup

At a Glance

The sub-program **3_Setup** provides access to all basic settings.

Each function may be **modified** in any mode. The LUCM settings are different from the LUCMT settings.

⚠ WARNING
<p>INCORRECT SETTINGS</p> <p>The settings (parameters) may be changed in "Run" mode.</p> <p>Values may be defined via the network.</p> <p>External programming peripherals must have write privileges.</p> <p>The power must be applied to adjusted values.</p> <p>Use a password to prevent illicit changes.</p> <p>Failure to follow these instructions can result in death, serious injury, or equipment damage.</p>

3_Setup for LUCM

The current function is displayed on the second line of the display.

Sub-prog. (line 1)		Function (line 2)
3_Setup	 	31_FLASet 32_TestTrip 33_Pause 34_Language

31_FLASet for LUCM

The FLA value represents the nominal current absorbed by the motor. This value is used in most protection functions.

Adjustments are made to the nominal current at full load. You should use the value provided on the motor plate.



The range of settings depends on the reference of the multifunction control unit (six possible references). The minimum value is displayed by default. Values are increased/decreased in steps of 1.

	LUCMX6BL	LUCM1XBL	LUCM05BL	LUCM12BL	LUCM18BL	LUCM32BL
 	= 0.15 A (min.)	= 0.35 A (min.)	= 1.25 A (min.)	= 3 A (min.)	= 4.5 A (min.)	= 8 A (min.)
	to	to	to	to	to	to
	? 0.6 A (max.)	? 1.4 A (max.)	? 5 A (max.)	? 12 A (max.)	? 18 A (max.)	? 32 A (max.)

⚠ WARNING
<p>INCORRECT FLA SETTING</p> <p>The FLA setting must represent the nominal current when the motor is at full load.</p> <p>The FLA setting defines the default values of the other motor protection functions.</p> <p>Failure to follow these instructions can result in death, serious injury, or equipment damage.</p>



32_TestTrip for LUCM

To test the trigger function on a thermal overload:

32_TestTrip	 	= No (default)	No action. To adjust the thermal memory (see <i>43_RstAdjust, page 47</i>).
		? Yes	Launches a trigger simulation, as long as the starter is in the "Run" position and displays Tripped / TestTrip . In " Manual reset " mode, the acknowledgement must be performed manually (rotary button). In " Remote reset " mode, the starter is powered off without triggering the mechanics. In " Automatic reset " mode, the starter is powered off without triggering the mechanics. After the timeout for the thermal memory has expired, the multifunction control unit automatically acknowledges the trip and the motor-starter restarts (this option requires the use of a 2-wire 24 V DC control). After a test trip, the multifunction control unit will only authorize a restart after the time delay associated with the thermal memory (default time: 120 s) has elapsed.
To exit the TestTrip function, reset using the rotary button ("Warn-OL" is displayed for a few seconds). Press ENT to return to the Main Menu / Reference_1 .			

33_Pause for LUCM

To put the motor on pause:

33_Pause <i>(version V1.x only)</i>	 	= No (default)	Puts the motor on pause in " Run " mode. The multifunction control unit powers off the starter coil, thereby opening the power poles while maintaining terminals A1/A2 powered on. Powering off the control circuit via terminals A1/A2, when the product is in " Pause " mode does not change the status of the command. The product returns to " Pause " mode as soon as power reappears. Keeps the power poles closed while terminals A1/A2 are powered on
		? Yes	Puts the motor on pause, causing the power poles to open.
To exit Pause mode, press ENT to return to the Main Menu / Reference_1 . Return to 3_Setup , then 33_Pause , and set the value to = No .			

⚠ WARNING

UNEXPECTED MOTOR START-UP



The **Pause** function must never be used instead of a stop command.

The device must be operated in compliance with national and local safety codes.

Failure to follow these instructions can result in death, serious injury, or equipment damage.



34_Language for LUCM

To change the language for dialogs:

34_Language	 	= English	Change the dialog language for the multifunction control unit. First choice made in Config Menu . Dialogs in English (default)
		? Français	Dialogs in French
		? Español	Dialogs in Spanish
		? Deutsch	Dialogs in German
		? Italiano	Dialogs in Italian

3_Setup for LUCMT

The current function is displayed on the second line of the display.



Sub-prog. (line 1)		Function (line 2)
3_Setup	 	31_FLASet 32_TestTrip 34_Language

31_FLASet for LUCMT

The FLA value represents the nominal current absorbed by the motor. This value is used in most protection functions.

Adjustments are made to the nominal current at full load. You should use the value provided on the motor plate.

The range of settings is determined by the value of **CT_Ratio** defined in the **Config Menu**. The minimum value is displayed by default. Values are increased/decreased in steps of 1.

CT_Ratio						
	30:3	30:2	30:1	50:1	100:1	200:1
 	= 3.5 A (min.) to ? 10.5 A (max.)	= 5.2 A (min.) to ? 15.7 A (max.)	= 10.5 A (min.) to 31.5 (max.)	= 17.5 A (min.) to ? 52.5 A (max.)	= 35 A (min.) to ? 105 A (max.)	= 70 A (min.) to ? 210 A (max.)
	400:1 = 140 A (min.) to ? 420 A (max.)	800:1 = 280 A (min.) to ? 840 A (max.)	Others The displayed range depends on the CT_Ratio defined (3 param.)			

32_TestTrip for LUCMT

To test the trigger function on a thermal overload:

32_TestTrip	= No (default)	No action. To adjust the thermal memory (see <i>43_RstAdjust, page 47</i>).
	? Yes	Launches a trigger simulation, as long as the starter is in the "Ready" or "Run" position and displays Tripped / TestTrip . In " Manual reset " mode, the acknowledgement must be performed manually. In " Remote reset " mode, the starter is powered off without triggering the mechanics. In " Automatic reset " mode, the starter is powered off without triggering the mechanics. After the timeout for the thermal memory has expired, the multifunction control unit automatically acknowledges the trip and the motor-starter restarts (this option requires the use of a 2-wire 24 V DC control). After a test trip, the multifunction control unit will only authorize a restart after the time delay associated with the thermal memory (default time: 120 s) has elapsed.
To exit the TestTrip function, reset by pressing the Reset button ("Warn-OL" is displayed for a few seconds). Press ENT to return to the Main Menu / Reference_1 .		

34_Language for LUCMT

To change the language for dialogs:

34_Language	= English	Change the dialog language for the multifunction control unit. First choice made in Config Menu . Dialogs in English (default)
	? Français	Dialogs in French
	? Español*	Dialogs in Spanish
	? Deutsch*	Dialogs in German
	? Italiano*	Dialogs in Italian

(* version V3.2 onwards)

Sub-program 4_AdvSetup

At a Glance

The **4_AdvSetup** sub-program is used to configure the protection functions and the associated warnings. Each function may be displayed in any mode.

Each function may be modified in the following modes:

- "Off" or "Pause" (LUCM)
- "Ready" (LUCMT)

4_AdvSetup

The current function is displayed on the second line of the display.

Sub-prog. <i>(line 1)</i>	Function <i>(line 2)</i>
4_AdvSetup	41_TripClass 42_ResetMode 43_RstAdjust 44_MagTrip <i>(not used for LUCMTs)</i> 45_OLWarning 46_GroundFlt 47_PhaseImb 48_Jam 49_UndrLd 410_LongStrt

41_TripClass

To choose the trip class:

41_TripClass	= 5 (default)	This value shows timeout (in seconds) prior to trigger for a thermal overload of 600% FLA. Settings can range from 5 to 30, in increments of 5 (see <i>Thermal trigger and reset graphs, page 72</i>). (see <i>31_FLASet for LUCM, page 41</i>).
	? 10	
	? 15	
	? 20	
	? 25	
	? 30	

⚠ CAUTION

TRIP CLASS SETTING INCORRECT

TripClass settings must fit the thermal capacity for the motor.



Failure to follow these instructions can result in injury or equipment damage.

42_ResetMode

To define the reset method after a fault has been detected:

Manual
Remote/Ent
Automatic

(see *Warning Management*, page 66).

 	= Manual (default)	Used to acknowledge locally after a fault trip.
	? Remote/Ent	Used to acknowledge remotely after a fault trip due to a 45_Thermal Overload, a 32_TestTrip, a 410_LongStrt, a 47_PhaseImb, a 49_UnderLoad, a 48_Jam of the motor, a stop signal sent by a function module or a communication fault. <i>==> Switch the device off, then on again, to acknowledge a thermal overload fault. This has no effect on the thermal memory. A new trigger may occur at restart if the control unit's internal thermal capacity level is exceeded.</i>
	? Auto	Used to automatically reset after a "thermal overload" fault.

 **DANGER**

UNEXPECTED MOTOR START-UP

If an "on" command is still active and the system is in "**Auto**" reset mode, the motor restarts after timeout.

The device must be operated in compliance with national and local safety codes.

Failure to follow these instructions will result in death or serious injury.

43_RstAdjust

The reset adjustment level is used to adjust the reset time (**ResetTime**) and the thermal capacity (**ResetLevel**) which both have to be reached before a thermal overload trip reset can be authorized (see *Thermal trigger and reset graphs, page 72*).

43_RstAdjust		ResetTime	<p>Adjusts timeout (in seconds) before reset after a thermal overload trip.</p> <p>Use Manual reset or switch the command circuit off then on again using the A1/A2 terminals to reset after a thermal overload trip. This has no effect on the internal thermal memory.</p> <p>A new trigger may occur at restart if the multifunction control unit's internal thermal capacity level is exceeded.</p> <p>To adjust the thermal memory (see <i>43_RstAdjust, page 47</i>).</p> <p>Default value = 120. Settings range from 1 to 1000 seconds in increments of 1 second.</p>
		ResetLevel	<p>Lowest thermal capacity level required to authorize restart.</p> <p>Default value = 80% Settings range from 35 to 95% of thermal capacity, in increments of 5%.</p> <p>==> 100% of thermal capacity is reached if current value is 112% of FLA (see <i>31_FLASet for LUCM, page 41</i>).</p>

⚠ CAUTION

INCORRECT RESET TIMEOUT SETTING

Thermal reset timeout must be sufficient to allow motor to cool after a thermal trip.

See the motor manufacturer's instructions before adjusting this setting.

Failure to follow these instructions can result in injury or equipment damage.

44_MagTrip for LUCM

To adjust the over-current protection level for a starter-controller, on an LUCM control unit:

44_MagTrip		<p>= 1420% FLA (default)</p> <p>Settings can range from 300 to 1700 % FLA, in increments of 20%</p> <p>Any surge lasting over 100 ms causes the power Base mechanism to trigger.</p> <p>==> <i>This function is not available if the power Base is a Starter type (Starter, LUS../LU2S..) (see Configure an LUCM, page 33).</i></p> <p>==> 800% FLA ==> Starter-controllers.</p>
------------	---	---

NOTE: Any over-current trip causes the power Base mechanism to trigger and requires a **manual reset** (rotary button), regardless of which reset mode has been chosen (see *42_ResetMode, page 46*).

⚠ DANGER

INCORRECT OVER-CURRENT LEVEL SETTING

Device selection and configuration must comply with national and local safety codes.

Failure to follow these instructions will result in death or serious injury.

45_Overload

To activate the warning function for thermal overload protection:

45_OLWarning	⬅	Warning	Used to enable or disable the warning function. Default value is = On . The warning is triggered as soon as thermal capacity exceeds the preset level during the preset time span. It does not cause a product fault. <i>==> This alarm is deactivated when the thermal-capacity value falls to 95% of its activation threshold value.</i>
	⬇	Warn Level	If Warning = On, used to set the level beyond which the multifunction control unit activates the warning under thermal overload conditions. Default level= 85% . Settings range from 10 to 100% of thermal capacity, in increments of 1%. <i>==> 100% of thermal capacity is reached if permanent current value is 112% of FLA (see 31_FLASet for LUCM, page 41).</i>

46_GroundFit

To enable or disable and adjust the ground fault protection system, by acting on the following parameters:

Trip
TripTime
TripLevel
Warning
Warn Level





⚠ DANGER

INCORRECT SETTING FOR THE GROUND FAULT PROTECTION LEVEL

The ground fault protection level must be such that it protects motor cabling and equipment.
The settings must comply with national and local safety codes.

Failure to follow these instructions will result in death or serious injury.

A ground fault exists if the multifunction control unit detects that the currents in the three phases do not add up to zero during the preset timeout:

Trip		= On (default)	Used to enable (default) or disable the ground fault protection system. ==> When the parameter is enabled, any ground fault always triggers the power Base mechanism and requires a manual reset , regardless of which reset mode has been chosen (see <i>42_ResetMode</i> , page 46).
		? Off	
TripTime		= 1.0 s (default)	Time during which the control unit has detected a ground current value higher than the preset level, before triggering. Trigger timeout (= 1.0 s default). Settings range from 0.1 to 1.2 seconds, in increments of 0.1 second.
TripLevel		= x (30% FLA min default value)	Adjustment of the ground current level defining the trip condition. Minimum default setting = 30% FLA. Settings range from 20 to 500% of the setting range for the multifunction control unit being used, in increments of 10%. For example, for a LUCM1XBL (min FLA = 0.15 A), settings range from 0.03 to 0.75 A in increments of 0.01 A, with a default value of 0.04 A.
Warning		= On (default)	Enable (default value) or disable the ground fault protection warning. Warning is disabled when ground fault current falls to 95% of the trip level. A warning does not cause the system to trigger (product fault).
		? Off	
Warn Level		= x (30% FLA min default value)	If Warning = 'On', used to adjust the ground current level defining the warning condition. Settings range from 20 to 500% of min FLA for the setting range for the multifunction control unit being used, in increments of 10%. For example, for a LUCM1XBL (min FLA = 0.15 A), settings range from 0.03 to 0.75 A in increments of 0.01 A, with a default value of 0.04 A.

47_PhaseImb

To adjust the phase imbalance or phase loss protection settings when using a three-phase load:

Trip
TripTimeStrt
TripTimeRun
TripLevel
Warning
Warn Level

An imbalance fault condition is registered if the imbalance (expressed as a %) between the current on one phase and the average current on the three phases exceeds the preset value, over a time at least equal to the time displayed.

The time setting must apply to start conditions as well as normal running conditions.



==> *This function is not available for single-phase loads .*

⚠ WARNING
INCORRECT PHASE IMBALANCE LEVEL SETTING
The phase imbalance levels must be such that they protect motor cabling and equipment. This function is disabled with single-phase motor loads. The settings must comply with national and local safety codes. Failure to follow these instructions can result in death, serious injury, or equipment damage.

Trip	<input type="radio"/> = On (default) <input type="radio"/> ? Off	Used to enable or disable the phase imbalance or phase loss protection system. ==> The reset mode depends on the option selected (see 42_ResetMode, page 46).
------	--	--

TripTimeStrt	<input type="text" value="0.7"/> s (default)	Trigger timeout (Start). Used to adjust the "phase imbalance" timeout setting during start-up, prior to trigger. The range of settings, during the start-up phase, is from 0.2 to 20 seconds, in increments of 0.1 s. This time is applied if the imbalance condition appears during the start-up phase (see Start-up Phase, page 62)
--------------	---	---

TripTimeRun	<input type="text" value="5.0"/> s (default)	Trigger timeout (Run). Used to adjust the "phase imbalance" timeout setting after start-up, prior to trigger. The range of settings, after the start-up phase, is from 0.2 to 20 seconds, in increments of 0.1 s. This time is applied if the imbalance condition appears after the start-up phase (see Start-up Phase, page 62).
-------------	---	---





TripLevel		= 10 (default)	Trigger timeout (as a % of IMB) Used to adjust the imbalance level that determines a trip condition. Settings range from 10 to 30% of phase imbalance, in increments of 1%.
Warning		= On (default)	Used to enable or disable the phase imbalance or phase loss protection warning.
		? Off	Warning is disabled when imbalance falls below 95% of the trip level.
Warn Level		= 10 (default)	Used to adjust the phase imbalance level defining the warning condition (as a % of IMB). Settings range from 10 to 30% of phase imbalance, in increments of 1%.

48_Jam

A "jam" fault condition is registered if the current value exceeds the preset level during the preset time, after the end of the start-up phase (see *Start-up Phase, page 62*).

Used to adjust the mechanical jam protection settings:

Trip
TripTime
TripLevel
Warning
Warn Level

Trip		= Off (default)	Used to enable or disable the mechanical jam protection system.
		? On	==> The reset mode depends on the option selected (see <i>42_ResetMode, page 46</i>).
TripTime		= 5 s (default)	If Trip = On, can be used to adjust the setting for the current that initializes the trigger timeout. Adjust the time during which the multifunction control unit must detect a current value higher than the preset level, before triggering. The count-down only starts after the end of the start-up phase (see <i>Start-up Phase, page 62</i>). Settings range from 1 to 30 seconds, in increments of 1 second.
TripLevel		= 200 (default)	If Trip = On, used to adjust the trip level setting (as a % of FLA). Settings can range from 100 to 800 % FLA, in increments of 10%
Warning		= Off (default)	Used to enable or disable the mechanical jam protection warning.
		? On	Warning is disabled when imbalance falls below 95% of the trip level.
Warn Level		= 200 (default)	If Warning = On, can be used to adjust the setting for the current that initializes the timeout before warning activation (as a % of FLA). Settings can range from 100 to 800 % FLA, in increments of 10%

49_UnderLd

Underload and idling protection:

Trip
TripTime
TripLevel
Warning
Warn Level

Trip		= Off (default)	<p>Used to adjust the underload and idling protection settings.</p> <p>An "underload" fault condition is registered if the current value falls below the preset level during the preset time, after the end of the start-up phase (see <i>Start-up Phase, page 62</i>).</p> <p>Used to enable or disable the underload and idling protection settings.</p> <p>==> The reset mode depends on the option selected (see <i>42_ResetMode, page 46</i>).</p>
		? On	

TripTime		= 10 s (default)	<p>If Trip = On, can be used to adjust the trigger timeout setting.</p> <p>Used to adjust the time during which the multifunction control unit must detect a current value lower than the preset level, before triggering.</p> <p>The count-down only starts after the end of the start-up phase (see <i>Start-up Phase, page 62</i>).</p> <p>Settings range from 1 to 200 seconds, in increments of 1 second.</p>

TripLevel		= 50% FLA (default)	<p>If Trip = On, can be used to adjust the trip level setting.</p> <p>Used to adjust the setting for the current that initializes the trigger timeout.</p> <p>Settings can range from 30 to 100% FLA, in increments of 1%</p>

Warning		= Off (default)	<p>If Warning = On, can be used to enable or disable the warning.</p> <p>Warning is disabled when current value rises above 105% of the trip level.</p> <p>Enable or disable the underload and idling protection warning settings.</p>
		? On	

Warn Level		= 50% FLA (default)	<p>If Warning = On, can be used to adjust the setting for the current that initializes the count-down, before triggering the warning.</p> <p>Settings can range from 30 to 100% FLA, in increments of 1%.</p>

410_LongStrt

Used to adjust the long start protection settings:

Trip
TripTime
TripLevel
Warning
Warn Level

During the start-up phase, a long start "LongStrt" fault condition is registered if the current value exceeds the preset level during the preset time (see *Start-up Phase, page 62*).

==> *The Long Start function has no effect on the thermal overload protection function. If the thermal capacity level is reached during the start-up phase, the starter will trigger a "thermal overload" fault.*

Trip		= Off (default)	Used to enable or disable the long start protection system. ==> The reset mode depends on the option selected (see <i>42_ResetMode, page 46</i>).
		? On	

TripTime		= 10 s (default)	If Trip = On, can be used to adjust maximum duration for the start-up phase (in seconds) before triggering (see <i>Start-up Phase, page 62</i>). Settings range from 1 to 200 seconds, in increments of 1 second.

TripLevel		= 100 (default)	If Trip = On, can be used to adjust the setting for the trigger current, once the start-up phase has been completed (as a % FLA). Settings can range from 100 to 800 % FLA, in increments of 10%

Warning		= Off (default)	Enable or disable the long start protection warning. The warning ceases once the current falls 5% below the preset level or at the end of the start-up phase.
		? On	

Warn Level		= 100 (default)	If Warning = On, can be used to adjust the setting for the current that initializes the timeout before warning activation (as a % of FLA). Settings can range from 100 to 800 % FLA, in increments of 10%

Sub-program 5_CommSetup

At a Glance

The sub-program **5_CommSetup** is used to configure the Modbus RS 485 communication port, located on the multifunction control unit front panel.

Each function may be **configured** in the following modes:

- "Off" or "Pause" (LUCM)
- "Ready" (LUCMT)

The asynchronous RS 485 link supports the Modbus slave protocol.

The remote viewing or configuration devices, used to initialize communication by reading or writing data in the multifunction control unit 16-bit registers, must be Modbus masters.

NOTE: For detailed information on the Modbus protocol, visit <www.Modbus.org>.

⚠ WARNING

MISUSE OF COMMUNICATION PORT

Communication ports should only be used for non-critical data transfer.

Contactor and current level monitoring data can be delayed by transmission time lag and must not be used for critical command decisions.

The Off or Pause functions must not be used for emergency stops or for critical command applications.

Failure to follow these instructions can result in death, serious injury, or equipment damage.

5_CommSetup

The current function is displayed on the second line of the display.

Sub-prog. <i>(line 1)</i>	↕	Function <i>(line 2)</i>
5_CommSetup	↕ ↕	51_Drop 52_Baud 53_Parity 54_Control 55_CommLoss

51_Drop

Used to define the RS 485 communication port address. Select a Modbus slave number:

51_Drop	↕ ↕	= 1 (default)	Available numbers: 1 to 247, in increments of 1.
---------	--------	------------------	--

NOTE: Address 127 is reserved for a point-to-point connection. It must not be used for a network with more than one multifunction control unit.

Address 127 is reserved for a point-to-point connection with configuration software such as PowerSuite. Communication is possible in this way without knowing the address of the multifunction control unit.

All multifunction control units respond to address 127.

52_Baud

Used to define the Modbus transmission speed for the RS 485 communication port:

52_Baud	↕ ↕	= 19200 (default) ? 9600 ? 4800 ? 1200	Defines the frame transmission speed between the communication port and the connected device.	bps
---------	--------	--	---	-----

53_Parity

Used to define the asynchronous link parity for the RS 485 communication port:



53_Parity		? Even (default)	1 start bit, 8 data bits, 1 parity bit and 1 stop bit (total 11 bits).
		= None	1 start bit, 8 data bits and 1 stop bit (total 10 bits).

54_Control

Used to enable or to disable internal register records via the communication port.

If the function is disabled, write commands are only valid for the following registers:



- Remote keyboard (register 1100)
- Multifunction control unit status (register 704)
- Multifunction control unit extended status (register 705)
- Communication module or option configuration (registers 680-690)

54_Control		= On (default)	Used to enable or to disable internal register records via the communication port.
		? Off	

55_CommLoss

Starter behavior if communication is down for at least 10 s.

Response if communication is down:

55_CommLoss		= Ignore (default)	Disables communication port watchdog.
		? Dropout	To acknowledge, press the ENT button or send a command via the bus. (Register 704-bit 3)
		? Trip	This requires a manual reset .
		? Warning	Communication loss triggers a warning. The warning disappears once communication is restored.

Sub-program 6_Module

At a Glance

The **6_Module** sub-program is used to configure the module that reads and writes in the multifunction control unit registers.

Each function may be **modified** in any mode.

The module may be configured:

- either directly by keying in the codes,
- or remotely, by using the RS 485 serial communication port (see *RS 485 Serial Communication Port*, page 79).

See the documentation for each module for the code definitions.

6_Module

The current function is displayed on the second line of the display unit:

Sub-prog. (line 1)	Function (line 2)
6_Module	61_ID Clear 62_Reference 63_ID Set 64_Param dec 65_Param hex

61_ID Clear

Used to reset the module identification number while disabling the 'watchdog' function:

61_ID Clear	= Yes (default)	Module identification number reset.
	? No	



62_Reference

Used to display the commercial references for the module as written by the module in the multifunction control unit registers (**read only**):

62_Reference	Module ID = 0	Module identification code (line 2). "ID = 0" indicates no module, or unidentified module.
	Catalog ?	Module reference (line 2). If "ID = 0" ==> the module reference is replaced by "?".
	Firmware Rev: 0.00	Module firmware version number (line 2). If "ID = 0" ==> the firmware version is replaced by "0.00".

63_ID Set



Used to define the module identification code in the multifunction control unit to provide the monitoring and configuration functions:

63_ID Set	 	= 0 (default)	Identification code can range from 0 to 255, by increments of 1.
-----------	--	------------------	--

64_Param dec

Used to configure a parameter list, numbered 1 to 10, in decimal format, corresponding to communication module registers 681 to 690.



==> This function defines the same parameters as **65_Param hex**.

64_Param dec	 	Parameter 1-10 = 00000 (default)	(line 1) Parameter number (1 to 10). (line 2) Decimal setting. ==> Parameters may be set from 00000 to 65535.
--------------	--	--	---

65_Param hex

Used to configure a parameter list, numbered 1 to 10, in hexadecimal format, corresponding to communication module registers 681 to 690.

==> This function defines the same parameters as **64_Param dec**.

(6_Module) 65_Param hex	 	Parameter 1-10 = 0000 (default)	(line 1) Parameter number (1 to 10). (line 2) Hexadecimal settings. ==> Parameters may be set from 0000 to FFFF.
----------------------------	--	---------------------------------------	--

To set parameters 1 to 10 for the module, use either the **64_Param dec** function (decimal adjustment), or the **65_Param hex** function (hexadecimal adjustment).

Sub-program 7_Statistics

At a Glance

The **7_Statistics** sub-program is used to access the fault statistics saved in the multifunction control unit memory.

Each function may be **accessed** in the following modes:

- "Off " or "Pause" (LUCM)
- "Ready" (LUCMT).

The multifunction control unit records:

- **Trigger statistics:** information on the 5 most recent triggers (trigger type, average current, phase currents). This information is saved in the control unit just before power down.
==> Triggers caused by internal trips are not listed in the five most recent trigger events.
- **Trigger and off counters:** on, off, fault and trigger counter values since last reset.

NOTE: The **83_Rst stats** function is used to erase all statistics data.

7_Statistics

Current function is displayed on the second line of the digital display unit:

Sub-program (line 1)	Function (line 2)
7_Statistics	71_Trip0 72_Trip1 73_Trip2 74_Trip3 75_Trip4 76_Totals

71_Trip0

Last trip statistics:

71_Trip0	Type=xxxxxx (default)	Last trip type: (see <i>Fault Codes</i> , page 67).
	FLA= xxx A	Displays 31_FLASet immediately prior to trigger
	Therm= xxx%	Displays thermal capacity percentage.
	IAV= xxx A	Displays average motor current immediately prior to trigger.
	IL1= xxx A	Displays current L1 immediately prior to trigger.
	IL2= xxx A	Displays current L2 immediately prior to trigger.
	IL3= xxx A	Displays current L3 immediately prior to trigger.
	IGR= xxx A	Displays average ground fault current (IGR) immediately prior to trigger.



72_Trip1

Penultimate trip statistics:

72_Trip1	The parameters displayed for this function are identical to those displayed for function 71_Trip0.
----------	--



73_Trip2

Fault n-2 statistics:

73_Trip3	 	The parameters displayed for this function are identical to those displayed for function 71_Trip0.
----------	--	--



74_Trip3

Fault n-3 statistics:

74_Trip4	 	The parameters displayed for this function are identical to those displayed for function 71_Trip0.
----------	--	--





75_Trip4

Fault n-4 statistics:

75_Trip5	 	The parameters displayed for this function are identical to those displayed for function 71_Trip0.
----------	--	--

76_Totals

Statistics for all start, run and fault events:

76_Totals		Nbstarts	Number of starts.
		Auto Resets	Number of automatic resets.
		Shunt Trips	Number of triggers.
		ONhours	Number of hours in "On" mode
		SC Trips	Number of short circuit trips.
		MagTrip	Number of magnet trips.
		OL Trips	Number of thermal overload trips.
		GF Trips	Number of ground fault trips.
		Imbal Trips	Number of phase imbalance/phase loss trips.
		Jam Trips	Number of jam trips.
	 	UndrLd Trips	Number of underload (idle) trips.
	 	LongSt Trips	Number of long start trips.
		Comm Trips	Number of communication loss events on the RS 485 serial port.
		IntFlt	Number of internal multifunction control unit trips,
		OL Warns	Number of thermal overload warnings.
		Mod ID	Number of module ID trips (eg: incorrect ID or no module).
		Mod Int	Number of internal module trips.
		Mod Trp	Number of module trigger trips.
		Mod Drp	Number of module off trips.
		Statistics	END

Sub-program 8_Password

At a Glance

The **8_Password** sub-program is used to prevent unauthorized persons from configuring the multifunction control unit.

Each function may be **modified** in the following modes:

- "Off" or "Pause" (LUCM)
- "Ready" (LUCMT)



The ex-factory password (**0000**) inhibits password properties.

Passwords can range from 0001 to 9999.

This sub-program can also be used to **reset** the multifunction control unit (restore ex-factory values for the configured functions and history).

8_Password

The current function is displayed on the second line of the display unit:

Sub-prog. <i>(line 1)</i>	Function <i>(line 2)</i>
8_Password	81_Unlock  82_Lock  83_Rst Stats 84_RstToDfts

Password Lock and Unlock

To lock the code, initially, use the **82_Lock** function. Enter the code then confirm (2 entries). **DONE** is displayed.

Several options can be used to unlock the code:

1. Do you wish to unlock the code permanently?

Go to **82_Lock** where the HMI displays **Passwd? 0xxx**. Type in your code. The HMI will then ask you **New PSW? 0xxx**. Enter **0000** then **ENT**. Validate by re-entering **0000** then **ENT**). **Done** is displayed.

The **82_Lock** function must be used to relock the code.

2. Do you wish to unlock the code temporarily?

You may use one of two options:



- if a code has already been entered in **82_Lock**, either go to **81_Unlock**, which displays **Passwd? 0xxx**. Enter your code: "Logged On" will be briefly displayed,
- or go directly to the parameter you want to modify, where the HMI will ask for the code: **Passwd? 0xxx**. Enter your code: "Logged On" will be briefly displayed, You are then free to modify any other parameter, as long as you do not exit the **Main Menu** program.

The code is automatically re-locked if:

- you exit the **Main Menu** by pressing **ESC** several times, or
- you do not press a key for more than 30 seconds, or
- you switch off the control unit, or
- on a LUCM, on a LUB../LUS.. base, the auxiliary power supply and A1/A2 are down.

81_Unlock



This function disables the password security system. The **82_Lock** function must be disabled before any parameter changes can be made on the multifunction control unit.

81_Unlock		Passwd? (0001 - 9999)	<p>This function resets the unlocking sequence. The multifunction control unit displays Passwd?.</p> <ul style="list-style-type: none"> • Select first digit (0 to 9), using the  /  keys. • Press ENT to confirm the first digit and move on to the second. • Repeat the same sequence for the second, third and fourth digits. • Once you have pressed ENT to validate the fourth digit, the parameters can be changed.
-----------	---	--------------------------	--

82_Lock

Used to enable the multifunction control unit password security system. Password set to **0000** invalidates all function properties.

==> Current password (only when set to 0000) can be modified via the Modbus RS 485 communication port.

82_Lock		New PSW? (0001 - 9999)	<p>The Activate password function initializes the locking sequence. The multifunction control unit displays New PSW?.</p> <ul style="list-style-type: none"> • Select first digit (0 to 9), using the  /  keys. • Press ENT to confirm the first digit and move on to the second. • Repeat the same sequence for the second, third and fourth digits. • Once you have pressed ENT to validate the fourth digit == > the multifunction control unit displays Confirm...... • Re-enter the four digits as above. <p><i>==> Once the configuration has been secured, control and command functions can only be displayed.</i></p>
---------	--	---------------------------	---

83_Rst Stats

Used to reset all counters and fault histories (see **7_Statistics**).

==> No history value may be restored once this function has been validated. It is therefore recommended you save all history data beforehand.

==> Switching off the multifunction control unit will not reset the counters.

83_Rst Stats		= No (default)	Disables history reset.
		? Yes	Enables history reset and erases history.

84_RstToDfts

Restores default factory parameter settings for the multifunction control unit. Also resets statistics.

This function returns the user to the **Config Menu** program.

==> No settings can be restored once the function has been validated. It is therefore recommended that you use an external device to save all settings prior to use.

84_RstToDfts		= No (default)	Disables return to default settings.
		? Yes	Enables return to default settings, and resets all parameter sensitive functions to ex-factory values and resets history.

Start-up Phase

At a Glance

The start-up phase is the time it takes for the motor to reach nominal load current after A1/A2 power up. The duration of the start-up phase can be adjusted by using the **410_LongStrt** function, and is used to set the initial security function time lag: **47_PhaseImb**, **48_Jam** and **49_UnderLoad**.

Beginning of the Start-up Phase

The **beginning of the start-up phase** depends on the type of control unit in use.

- **Beginning of an LUCM start-up phase**

Occurs whenever the power poles are closed. Conditions required for the beginning of the start-up phase: the A1/A2 terminals must be powered up, the system must not be in "Pause" mode and no fault detected.

While the A1/A2 terminals are powered up, the beginning of the start-up phase occurs after each fault reset or as soon as the "Pause" mode is disabled.

==> A new start-up phase beginning is only possible if the power poles have been opened then closed, whatever the state of the power supply for the base.

- **Beginning of an LUCMT start-up phase**

Occurs every time an average current of more than 10% of FLA is detected.

Whenever average current value falls below 5% of FLA in the absence of a fault, the LUCMT control unit moves to "Ready".

No start-up will be detected, even when current is above the 10% threshold, if average current has not previously fallen below 5%.

End of Start-up Phase

The **end of the start-up phase** depends on different situations:

- If **410_LongStrt** is **disabled**:

Current exceeds threshold value, then falls below it before timeout (*see case no. 1*).

Current exceeds the threshold value, and is still above threshold at timeout (*see case no. 2*).

Current has not exceeded threshold value before timeout (*see case no. 3*).

- If **410_LongStrt** is **enabled**:

same principle as when Long start is disabled, but the FLA threshold and timeout are not preset:

- The current threshold can be adjusted between 100 and 800% of FLA (150% default value)
- The trigger setting can be set between 1 and 200 seconds (10 s default value)

End of Start-up Phase (Case No. 1)

When the start-up current falls below the 150% of FLA threshold:

- if the **Trip** or **Warning** parameters on **410_LongStrt** are **disabled**,
- **and if** current is above the 150% of FLA threshold,
- **and if** the time lag since Beginning of start-up is below 10 seconds.

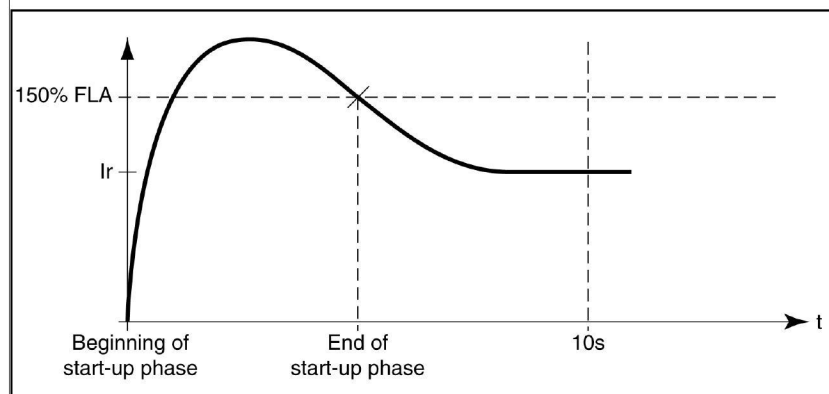

End of Start-up Phase (Case No. 2)

When current level falls after the 10 seconds time lag:

- if the **Trip** or **Warning** parameters on **410_LongStrt** are **disabled**,
- **and** if current is above the 150% of FLA threshold and remains at that level.

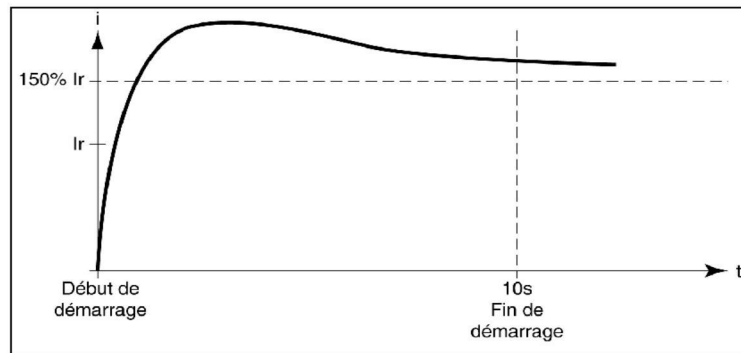
**End of Start-up Phase (Case No. 3)**

When current level falls after the 10 seconds time lag:

- if the **Trip** or **Warning** parameters on **410_LongStrt** are **disabled**,
- **and** if motor current never exceeds the 150% of FLA threshold.

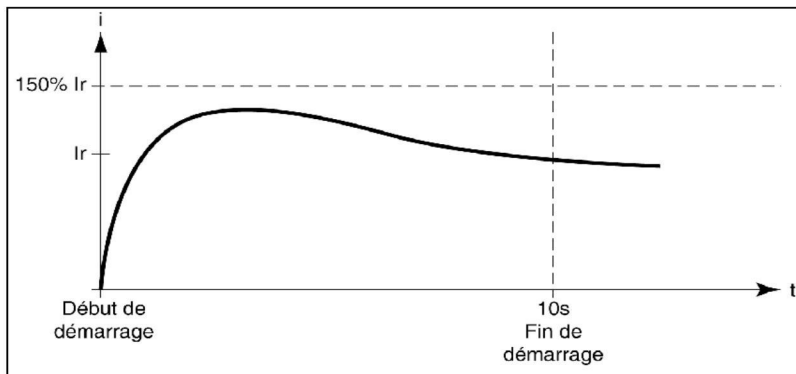



Warning and fault management

4

Warnings and faults

Warning management describes :

- the "Warning" mode,
- the warning names and codes.

Fault management describes :

- the "Fault" mode,
- the fault names and codes.

What's in this Chapter?

This chapter contains the following topics:

Topic	Page
Warning Management	66
Fault Management	67

Warning Management

"Warning" Mode

This mode only applies for warnings activated before the start-up phase:

- Overload, ground fault, and phase imbalance (activated with factory settings),
- jam, underload, and long start (parameters to set).

When a warning is triggered, **Warn** followed by the warning type is displayed on line 1. If a communication module is installed, the name is different.

NOTE: Once the timeout has expired, the corresponding warning type is displayed on line 1.

Using the **ENT** key, the user can move through the settings and check the **Warn Level** parameter value. The parameter setting may only be adjusted in **"Off"** mode.

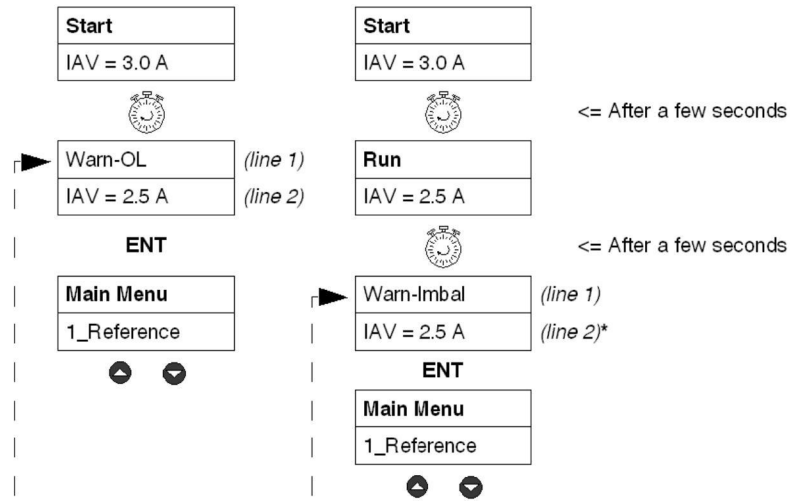

* See "Run" mode, page 32.

Warning codes and names

During a warning condition, a warning code is displayed in the monitoring registers 460 and 461. The history register 116 contains the number of thermal overload warnings since the last reset.

Meaning of terms appearing on the multifunction control unit screen and corresponding codes:

Line 1	Comment	Code
Warn-GF	Ground fault warning	3
Warn-OL	Thermal overload warning	4
Warn-LongSt	Long start warning	5
Warn-Jam	Mechanical jam warning	6
Warn-Imbal	Phase imbalance warning	7
Warn-UndrLd	Underload (idling) warning	8
Warn-IntTmp	Warning on the internal temperature of the multifunction control unit	11
Warn-Comm	Warning of lost communication in the multifunction control unit (RS 485)	10
Warning M109	Warning of lost communication with the communication module	109
Off-ModID	Warning generated by the multifunction control unit (communication module not recognized or unsuccessful communications with the module)	12

Line 2	Comment
	Fixed display (with factory settings) of the value of the average current (IAV) or loop with the parameters selected in the sub-program 2_Display , during "Run" mode.

Fault Management

"Fault" Mode

This mode only applies when fault monitoring has been activated before the start-up phase:

- **Motor safety protection faults**, factory enabled. All such faults can be configured, except short-circuit.
- **Tests** designed to artificially trigger installation monitoring faults.
- **Internal or external faults** related to product environment (with or without a communication module, ...).

Fault occurs after timeout.

Using the **ENT** key, the user can move through the settings and check the **TripLevel** parameter value. The parameter setting may only be adjusted in "Off" mode.

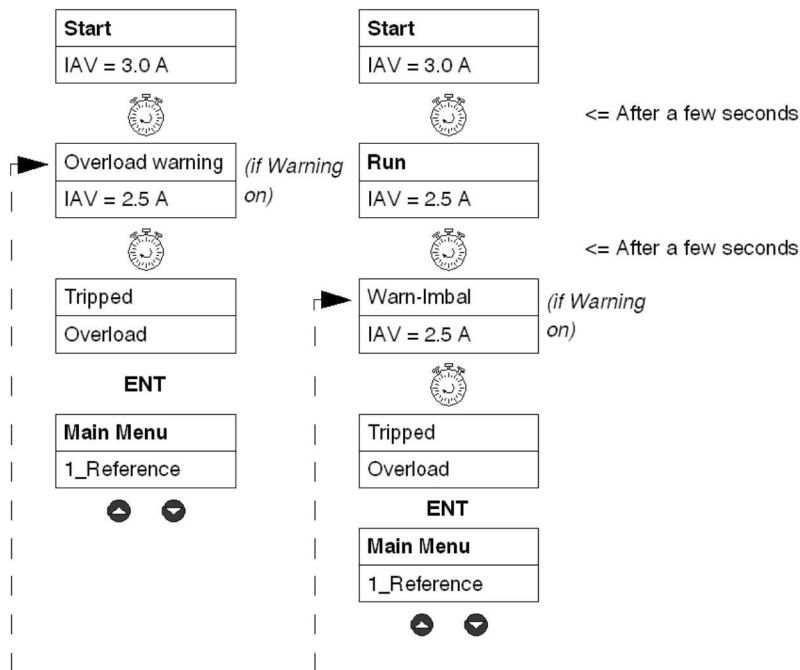

Returns to current mode if no key is pressed for 30 seconds.

With **LUCM** multifunction control units, fault messages may only be viewed with a 24 V DC auxiliary power supply and acknowledgement of "Off" faults always results in a motor restart if power is still supplied from the A1/A2 terminals.

Fault Codes

A fault code is displayed in:

- Fault monitoring registers 451-452
- Fault history registers 150-157, 180-187, 210-217, 240-247 and 270-277 (except for internal or external faults)

Fault Tables

The following fault tables specify:

- The type of associated multifunction control unit (LUCM, LUCMT)
- The fault code
- The fault name
- The type of associated reset mode (M=manual, R=remote, A=automatic)
- The keyboard display (lines 1 and 2)
- The type of reset action required of the user

Motor Safety Protection Faults

LUCM	LUCMT	Code	Fault	M	R	A	Line 1	Line 2	Action/Reset
√		1	Short circuit	√			Tripped	CC	Manual action
√		2	Over-current	√			Tripped	I>>	Manual action
√	√	3	Ground fault	√			Tripped	GroundFit	Manual action
√	√	4	Thermal overload	√			Tripped	Overload	Manual action
					√		Off-OL	Wait xxx then ENT => reset	Remote or ENT
						√	Off-OL	Auto xxx	Automatic
√	√	5	Long start-up	√			Tripped	LongStrt	Manual action
					√		Off-LongSt	-	Remote or ENT
						√	Off-LongSt	-	Automatic
√	√	6	Mechanical jam	√			Tripped	Jam	Manual action
					√		Off-Jam	-	Remote or ENT
						√	Off-Jam	-	Automatic
√	√	7	Phase imbalance	√			Tripped	PhasImb	Manual action
					√		Off_Imbal	-	Remote or ENT
						√	Off_Imbal	-	Automatic
√	√	8	Underload (idling)	√			Tripped	UndrLoad	Manual action
					√		Off-UndrLd	-	Remote or ENT
						√	Off-UndrLd	-	Automatic

Tests

LUCM	LUCMT	Code	Fault	M	R	A	Line 1	Line 2	Action/Reset
√	√	10	Trigger test (remotely via communication bus or via the 32_TestTrip menu)	√			Tripped	TestTrip	Manual action
					√		Off-Test	Wait xxx then ENT => reset	Remote or ENT
						√	Off-Test	Auto xxx	Automatic

Internal or External Environment-related Faults

This fault category includes:

- Communication faults
- Internal LUCM or LUCMT control unit faults
- Internal communication module faults
- Internal controller faults

Communication faults:

LUCM	LUCMT	Code	Fault	M	R	A	Line 1	Line 2	Action
√	√		RS 485 communication loss (value in menu 55)	√					
		12	... if "Tripped"		√		Tripped	CommLoss	Manual action
		11	... if "Off"			√	Off-Comm	ENT=>reset	Remote or ENT

Internal LUCM or LUCMT control unit faults:

No system trigger following internal fault display: faulty components may need changing.

LUCM	LUCMT	Code	Fault	Line 1	Line 2	Action/Reset
√	√	51	Multifunction control unit internal temperature	Int Trip	51	Check ambient temperature and distances (see <i>Service temperature, page 14</i>) Manual action
√	√	52	Electronic fault	Int Trip	52	Replace multifunction control unit Manual action
√	√	53		Int Trip	53	
√	√	54		Int Trip	54	
√	√	55		Int Trip	55	
√	√	56		Int Trip	56	
√	√	57		Int Trip	57	
√	√	58		Int Trip	58	
√	√	59	Motor current detection, no power supply to coil in "Pause", "Fault" or "Off" mode	Int Trip	59	Check coil cabling Manual action
√	√	60	L2 current detected in monophase mode	Int Trip	60	Check L2 cabling (1-3) (error if 1-2 or 2-3) Manual action
√	√	61	Undetected base change	Int Trip	61	Manual action
√	√	62	Control cabling fault	Int Trip	62	
√	√	63	Coil control circuit over-voltage	Int Trip	63	
√	√	64	FRAM error	Int Trip	64	Replace multifunction control unit
√	√	EEPROM error	-	Int Trip	EEPROM error	Replace multifunction control unit

NOTE: Internal multifunction control unit faults are not saved in the fault history registers.

Internal communication module faults:

LUCM	LUCMT	Code	Fault	Line 1	Line 2	Action/Reset
√	√	M1xx	Internal communication module fault	Off-M1xx e.g.: Off-M15	ENT=>reset	See relevant communication module user guide for more details.

Internal controller faults:

LUCM	LUCMT	Code	Fault	Line 1	Line 2	Action/Reset
√	√	M2xx	Internal LUTM controller fault	Off-M2xx	ENT=>reset	See relevant LUTM controller user guide for more details.

Fault Acknowledgement

Motor can be restarted once fault has been eliminated and acknowledged. A timeout of several seconds may be required for some faults (overload, tests). See relevant tables.

Additional information

5

The following section describes the trigger and reset graphs, the Powersuite software workshop, and the technical specifications for LUCM and LUCMT control units.

What's in this Chapter?

This chapter contains the following topics:

Topic	Page
Thermal trigger and reset graphs	72
Powersuite Firmware Workshop	77
Technical Characteristics	78

Thermal trigger and reset graphs

Thermal Trigger Graphs

The thermal trigger graphs are determined by the state of the motor:

- Hot motor (LUCM and LUCMT graphs differ)
- Cold motor (LUCM and LUCMT graphs differ)

Hot Motor Trigger Graphs (LUCM)

Time before reset - hot motor - for LUCM:

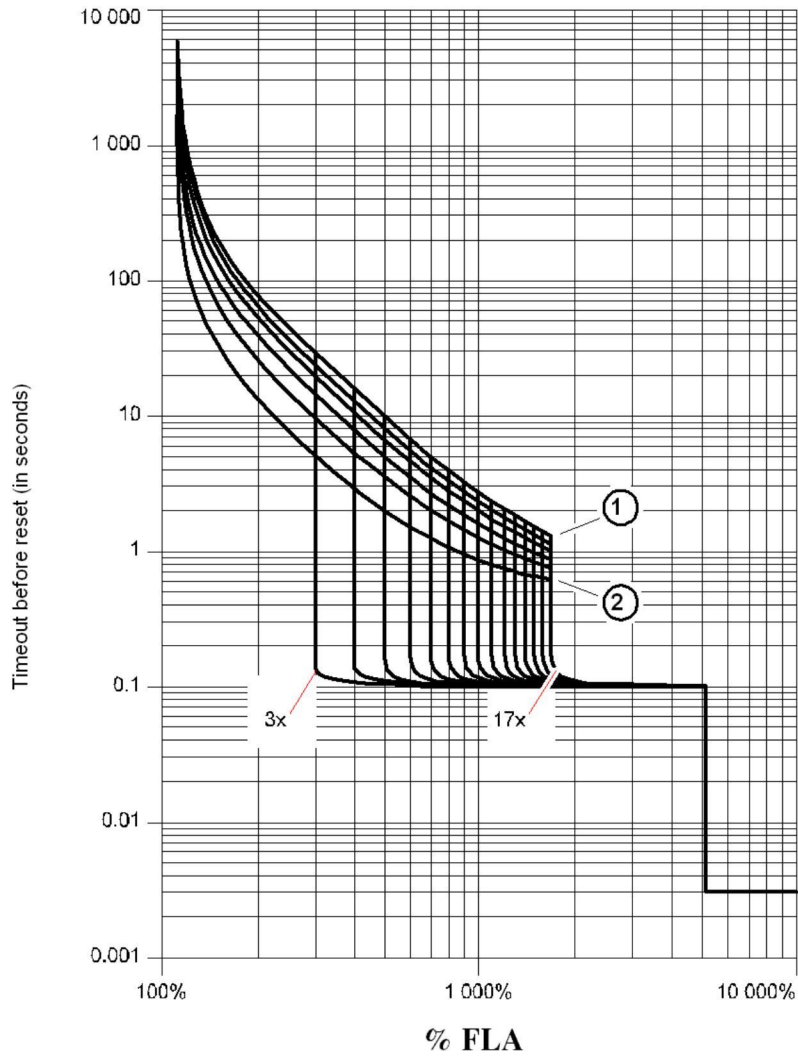

- 1 TripClass 30
- 2 TripClass 5

Hot Motor Trigger Graphs (LUCMT)

Time before reset - hot motor - for LUCMT:

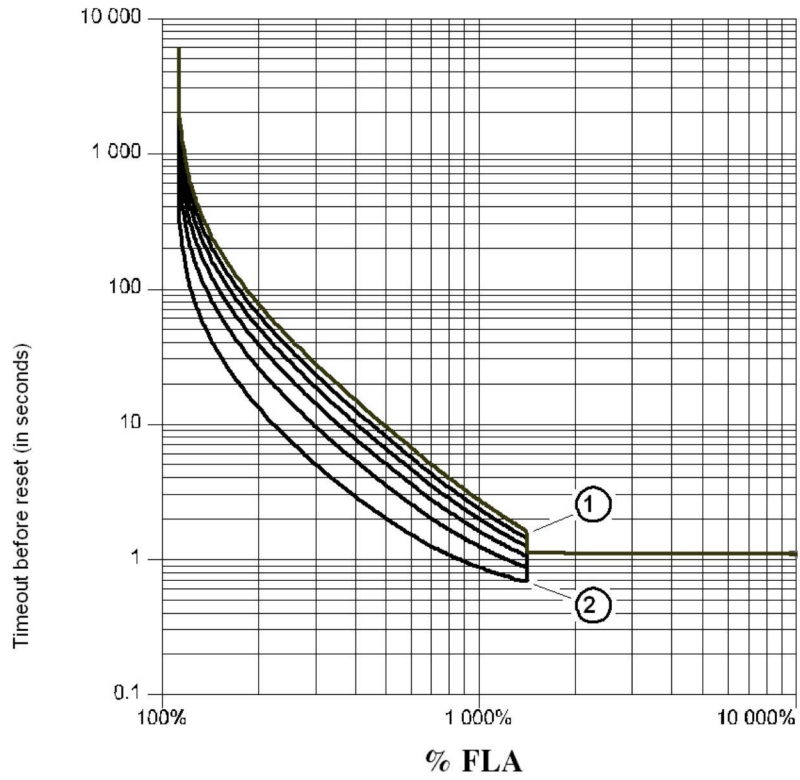

- 1 TripClass 30
- 2 TripClass 5

Cold Motor Trigger Graphs (LUCM)

Time before reset - cold motor - for LUCM:

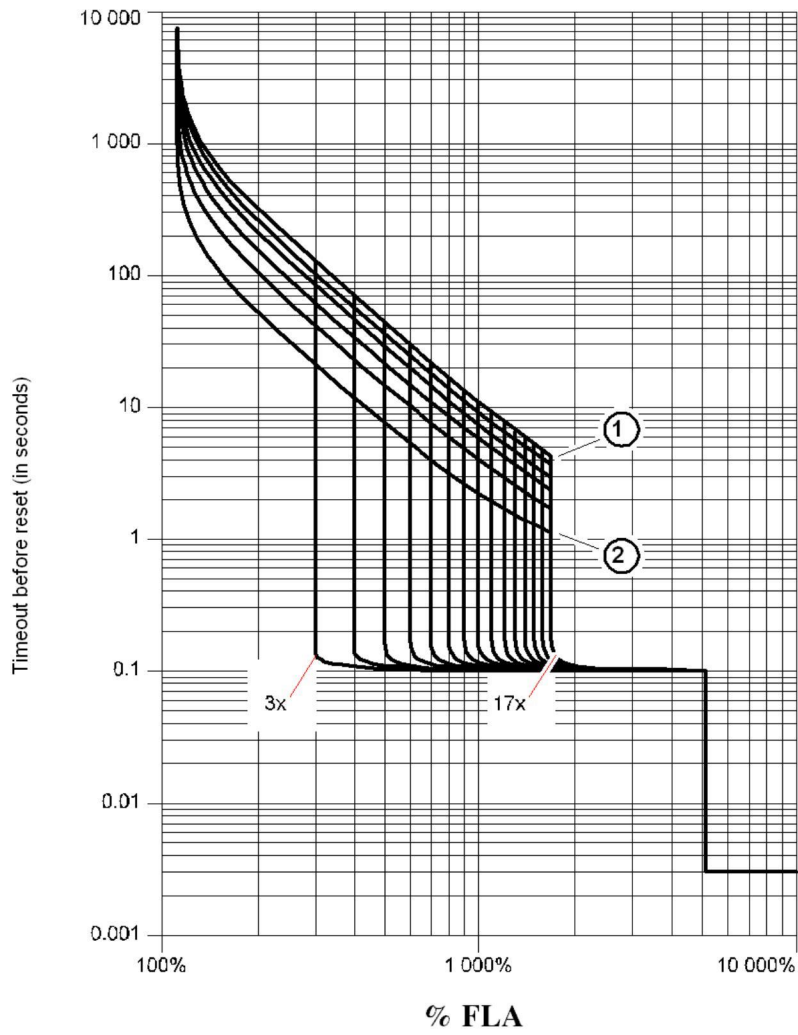

- 1 TripClass 30
- 2 TripClass 5

Cold Motor Trigger Graphs (LUCMT)

Time before reset - cold motor - for LUCMT:

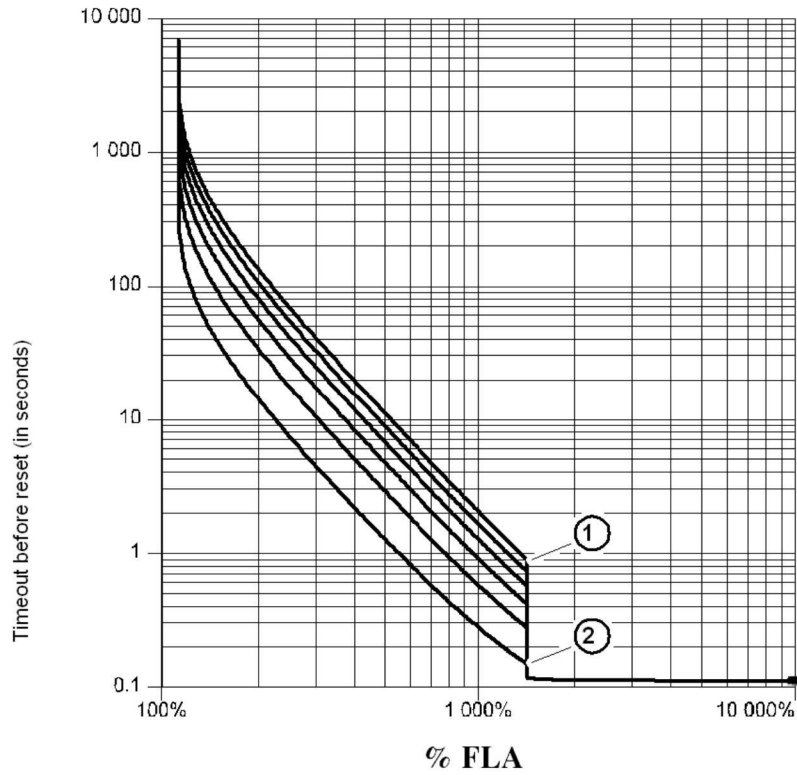

- 1 TripClass 30
- 2 TripClass 5

Reset Curves

The reset curves differ according to the type of motor:

- Self-cooled motor
- Motor with auxiliary fan.

Reset Graphs – Self-Cooled Motor

Time before reset - motor not cooled by an auxiliary fan:

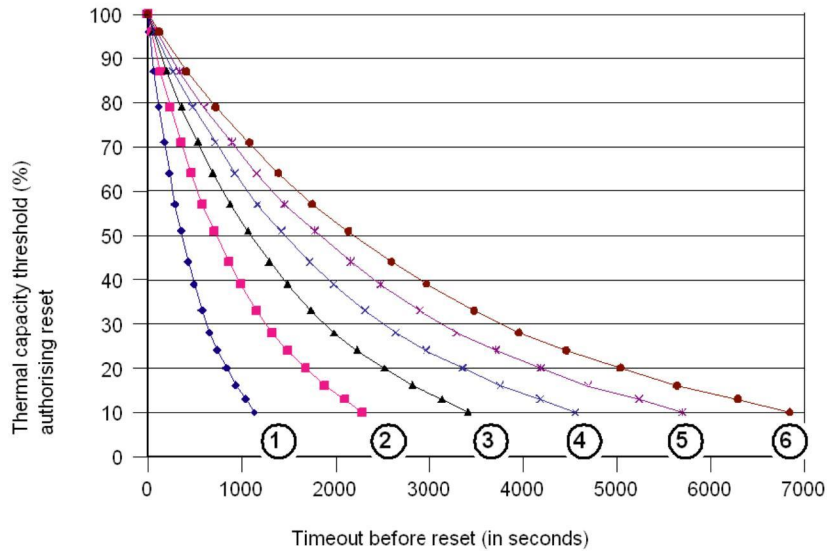

- 1 TripClass 5
- 2 TripClass 10
- 3 TripClass 15
- 4 TripClass 20
- 5 TripClass 25
- 6 TripClass 30

Reset Graphs – Auxiliary Fan-Cooled Motor

Time before reset - motor cooled by an auxiliary fan:

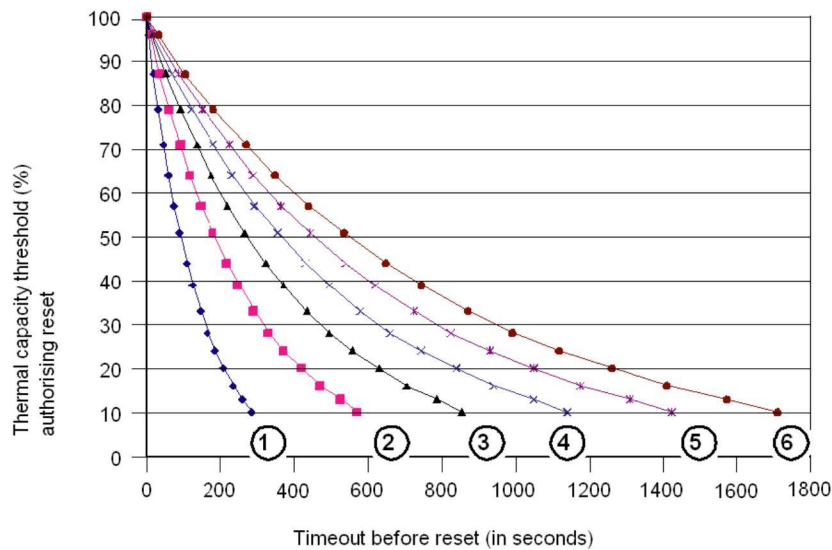

- 1 TripClass 5
- 2 TripClass 10
- 3 TripClass 15
- 4 TripClass 20
- 5 TripClass 25
- 6 TripClass 30

Powersuite Firmware Workshop

At a Glance

The Powersuite firmware workshop (version \geq V1.40) is used to configure and commission the control unit via a PC in a Microsoft Windows 95, 98, NT4, 2000 or XP environment.

Use

The workshop may be used:

- **In standalone mode** to prepare and save configuration files for the LUCM control unit on various media (floppy disk, CD-Rom, hard disk, etc.).
The configuration for the control unit may be printed out on paper or exported to standard office software.
- **Connected to the control unit Modbus port** to configure, adjust and set the various motor safety protection functions or to download a PC configuration file to or from the control unit.
A control panel can be used to display the statuses and current values for the starter-controller. This serves as a user-friendly control panel, allowing the user to monitor the main features for the starter unit in real time:
 - thermal capacity
 - motor current average value and phase value
 - ground fault current
 - phase imbalance percentage
 - starter statuses and safety function warnings

HMI

The thermal overload and over-current protection test controls are available on the control panel.

The panel is also used to implement and display the control unit configuration, monitoring, status and command registers. Configuration register contents may be modified.

Typical Powersuite monitoring control panel:

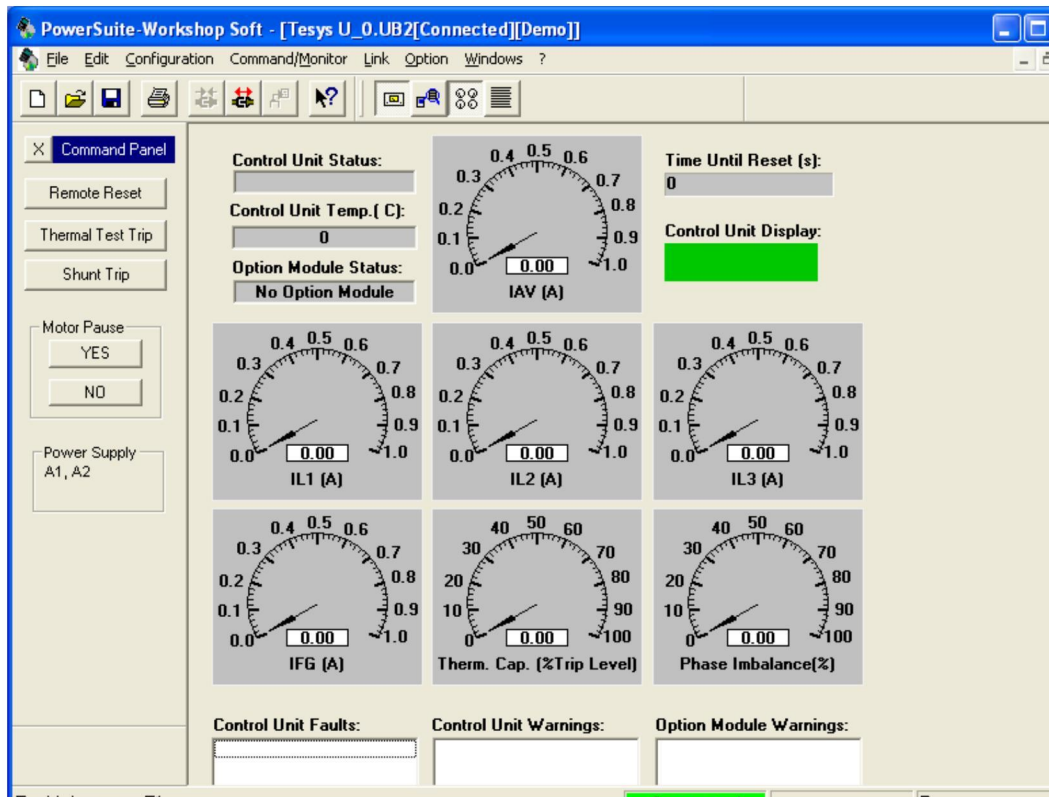

Technical Characteristics

Types of Characteristic

The technical characteristics of the LUCM and LUCMT include:

- Environmental characteristics
- Characteristics of the RS 485 serial communication port using an RJ-45 connector

The specific technical characteristics of the LUCM include:

- Characteristics of the power circuit
- Characteristics of the auxiliary power supply circuit

Environmental Characteristics

General characteristics of the LUCM and LUCMT multifunction control unit:

Certification			UL 508, CSA	
Conformity to standards	IEC 947-4-1, IEC 34-11, IEC 755, VDE 0106, VDE 0660			
European Community directives	CE marking. Satisfies the key requirements of the low-voltage equipment and electromagnetic compatibility directives.			
Protection treatment			"TH" tropical finish	
Protection level	According to IEC 60947-1		IP 20	
	For LUCM: only when the power cabling of the Power base exceeds the following widths: 1.5 mm ² (16 AWG) with end piece or 2.5 mm ² (14 AWG) without end piece.			
Level of pollution	According to IEC 60664		3	
Shock resistance	According to IEC 60068-2-27	10g open, 15g closed, 11 ms		
Resistance to vibrations	According to IEC 60068-2-6	2g open, 4g closed, 5 to 150 Hz		
Ambient air temperature near the device	Storage	- 35 to + 85°C (- 31 to + 185°F)		
	Operation (see <i>Service temperature, page 14</i>).		°C -20 to +60 °F -4 to +140	
Fire resistance	According to UL 94		V2	
Maximum operating altitude		m ft	2000 6562	
Operating position	Compared to the normal vertical mounting position. Front view of product: - 30° front-to-back rotation compared to vertical - 90° left or right rotation compared to horizontal			
Resistance to electrostatic discharge	According to IEC 61000-4-2 lev. 3	kV	8	
Resistance to radiated fields	According to IEC 61000-4-2 lev. 3	V/m	10	
Resistance to fast electrical transitions	According to IEC 61000-4-4 lev. 4	kV	4	
Resistance to dissipative shock waves	According to IEC 61000-4-5		Common mode	Serial mode
	Power circuit	kV	6	4
	Control circuit	kV	1	0.5
	Communication circuit	kV	1	-
Resistance to radio fields	According to IEC 1000-4-6 when 46_GroundFlt + TripLevel is < 50% of minimum FLA			3
	According to IEC 1000-4-6 when 46_GroundFlt + TripLevel is > 50% of minimum FLA			10
Voltage assigned to shock resistance (U imp)	According to IEC 60947-1	kV	2	
Resistance to disturbances due to low frequency harmonics	According to IEC 60947-2 Appendix F article F4.1			
Resistance to power line disturbance	According to IEC 61000-4-11			

RS 485 Serial Communication Port

Characteristics of the RS 485 serial communication port using an RJ-45 connector.

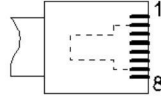
Electrical interface	RS 485								
Connector	RJ-45								
Connector pin-out RJ-45	Male connector, top view								
	<table style="margin-left: auto; margin-right: auto;"> <tr> <td style="text-align: center;">D(A)</td> <td style="text-align: right;">5</td> </tr> <tr> <td style="text-align: center;">D(B)</td> <td style="text-align: right;">4</td> </tr> <tr> <td style="text-align: center;">+ 5 V</td> <td style="text-align: right;">7</td> </tr> <tr> <td style="text-align: center;">Common</td> <td style="text-align: right;">8</td> </tr> </table> 	D(A)	5	D(B)	4	+ 5 V	7	Common	8
D(A)	5								
D(B)	4								
+ 5 V	7								
Common	8								
Insulation	V	1 kV							
Maximum line length	m (ft)	1000 m (3280 ft)							
Maximum length of a shunt	m (ft)	20 m (65 ft)							
Parity	Even - 1 start bit, 8 data bits, 1 parity bit and 1 stop bit (total 11 bits, default setting)								
	None - 1 start bit, 8 data bits and 1 stop bit (total 10 bits).								
Connector	<p>The 54 Control function (Write enable) enables (On) or disables (Off) write access to the configuration registers of the multifunction control unit.</p> <p>When control authorization is "Off", write commands are limited to the following registers:</p> <ul style="list-style-type: none"> ● Remote keyboard (register 1100) ● Multifunction control unit status (register 704) ● Multifunction control unit extended status (register 705) ● Communication module or option configuration (registers 680-690) 								
RTU Modbus commands	<p>RTU Modbus query codes supported:</p> <ul style="list-style-type: none"> ● Code 03 (03 Hex) - Read multiple registers (maximum 100 registers) ● Code 06 (06 Hex) - Write to one register ● Code 16 (10 Hex) - Write multiple registers (maximum 100 registers) ● Code 43 (2B Hex) MEI 14 (0E Hex) only - Schneider Electric private identification query, compliance level 01 ● Code 65 (41 Hex) - Private identification query 								
	<p>RTU Modbus response codes supported:</p> <ul style="list-style-type: none"> ● Code 03 (03 Hex) - Normal response to read multiple registers ● Code 06 (06 Hex) - Normal response to write one register ● Code 16 (10 Hex) - Normal response to write multiple registers ● Code 43 (2B Hex) - Normal response with the following parameters: VendorName = "TELEMECANIQUE" or "SCHNEIDER ELECTRIC" ProductCode = "LUCMxxBL", where xx corresponds to the model number MajorMinorRevision = "yyyy", where yyyy corresponds to the firmware revision ● Code 65 (41 Hex) - Response to a private identification query: { 0x01, '-', 0x01, '-', 'L', 'U', 'C', 'M', 'X', 'X', 'B', 'L', ' ', ' ', ' ', ' ', 0x00, 0x00, 0x00 } 'X', 'X': according to the reference of the multifunction control unit 								
	<p>RTU Modbus exception response codes supported:</p> <ul style="list-style-type: none"> ● Code 01 - Illegal function ● Code 02 - Illegal register number ● Code 03 - Illegal data value (write command interrupted) 								

Power Circuit (LUCM)

Characteristics of the power circuit of the LUCM multifunction control unit:

Range of usage voltage	Un	V	110 to 690 V AC
Voltage assigned to insulation (Ui)	According to IEC 947-1	V	690 V AC
Usage frequency		Hz	47-63
	For use with AC 110..690 V, 50..60 Hz motors. Not designed for use with DC motors. <ul style="list-style-type: none"> ● Certified for use upstream from variable-frequency drives ● Not certified for use downstream from variable-frequency drives 		
Nominal usage current	LUCMx6BL	A	0.15 to 0.6
	LUCM1xBL		0.35 to 1.4
	LUCM05BL		1.25 to 5
	LUCM12BL		3 to 12
	LUCM18BL		4.5 to 18
	LUCM32BL		8 to 32

Auxiliary Power Supply Circuit (LUCM)

Characteristics of the auxiliary power supply circuit of the LUCM multifunction control unit:

Range of usage voltage		V	20.4 to 31.2 V DC
Voltage assigned to insulation (Ui)	According to IEC 947-1	V	250 V AC
Connection			
- Rigid or flexible wire	1 conductor	mm ² (AWG)	0.2 to 1.5 (24 to 16)
- Flexible wire with end piece	1 conductor	mm ² (AWG)	0.25 to 1.5 (24 to 16)
- Rigid wire	2 conductors	mm ² (AWG)	0.2 to 1 (24 to 18)
- Flexible wire	2 conductors	mm ² (AWG)	0.25 to 1.5 (24 to 16)
Tightening torque (auxiliary power supply circuit)		N.m (lb-in)	0.5 to 0.6 (4.6 to 5.6)

Glossary

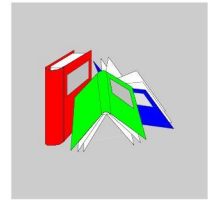

0-9

% Capacity

Percentage of thermal capacity.

% FLA

Percentage of motor current setting.

% IMB

Percentage of phase imbalance.

E

Even (parity)

1 start bit, 8 data bits, 1 parity bit and 1 stop bit (total 11 bits).

F

FLA

Motor current setting.

I

IAV

Average motor current $(L1 + L2 + L3 / 3)$.

IL1, 2, 3

Current L1, L2, L3.

M

Max FLA

Maximum FLA range current.

Min FLA

Minimum FLA range current.

N

None (parity)

Start bit, 8 data bits and 1 stop bit (total 10 bits).

R

Reset threshold

Lowest thermal capacity threshold required to authorize restart.

Reset time

Timeout (in seconds) before reset after thermal overload trip.

T

Trip

Any situation that trips the product and

- causes the terminals to open (LUCM),
- causes contacts 05-06 and 95-96 to open and contacts 97-98 to close (LUCMT).

Index

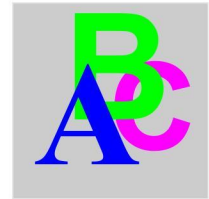

0-9

1_Reference, 39
11_Catalog, 39, 39
12_Firmware, 39, 39
13_FLA Range, 39, 39
14_LoadType, 39, 39
15_AuxFan, 39, 39
16_Base, 39, 39
2_Display, 40
21_AvCurrent, 40, 40
22_ThermCap, 40, 40
23_I L1, 40, 40
24_I L2, 40, 40
25_I L3, 40, 40
26_GFCCurrent, 40, 40
27_Trip, 40, 40
28_PhaseImb, 40, 40
29_ONhours, 40
3_Setup, 41
31_FLASet, 41, 43
32_TestTrip, 42, 44
33_Pause, 42
34_Language, 42, 44
4_AdvSetup, 45
41_TripClass, 45
410_LongStrt, 53
42_ResetMode, 46
43_RstAdjust, 47
44_MagTrip, 47
45_Overload, 48
46_GroundFlt, 48
47_PhaseImb, 50
48_Jam, 51
49_UnderLd, 52
5_CommSetup, 54
51_Drop, 54
52_Baud, 54
53_Parity, 55
54_Control, 55
55_CommLoss, 55
6_Module, 56
61_ID Clear, 56
62_Reference, 56
63_ID Set, 57
64_Param dec, 57
65_Param hex, 57
7_Statistics, 58
71_Trip0, 58
72_Trip1, 58
73_Trip2, 59
74_Trip3, 59
75_Trip4, 59

76_Totals, 59
8_Password, 60
81_Unlock, 61
82_Lock, 61
83_Rst Stats, 61
84_RstToDfts, 61

A

AdvSetup, 45
AuxFan, 34, 35
AuxFan (1_Reference), 39, 39
Auxiliary power supply circuit, 80
AvCurrent, 34
AvCurrent (2_Display), 40, 40

B

Base
 power, 34
Base (1_Reference), 39, 39
Baud, 54

C

Catalog (1_Reference), 39, 39
Code lock, 61
CommLoss, 55
CommSetup, 54
Configuration and monitoring, 11
Configuration during commissioning, 19
Connection, 15
Control, 55
CT_Ratio, 36
Curve
 reset, 75

D

Default settings
 LUCM, 20
 LUCMT, 23
Description, 12
Display, 12
Display (menu), 40
Distance to be maintained, 14
Drop, 54

E

Electrical supply, 18
 ENT, 13
 Environmental characteristics, 78
 ESC, 13

F

Fault
 CC, 68
 code, 67
 CommLoss, 69
 GroundFlt, 68
 I>>, 68
 Jam, 68
 LongStrt, 68
 Overload, 68
 PhasImb, 68
 TestTrip, 68
 UndrLoad, 68
 Fault codes, 67
 Firmware (1_Reference), 39, 39
 FLA Range (1_Reference), 39, 39
 FLASet
 for LUCM, 41
 for LUCMT, 43
 Functions
 Diagnostic, 11
 of the Main Menu program, 30
 Protection, 11
 Warning, 11
 Functions
 of the Config Menu program, 28

G

GFCCurrent (2_Display), 40, 40
 Graph
 thermal trigger, 72
 Ground fault, 48

I

I L1 (2_Display), 40, 40
 I L2 (2_Display), 40, 40
 I L3 (2_Display), 40, 40
 ID Clear, 56
 ID Set, 57
 Imbalance, 50
 Installation, 14
 Interface, 28

J

Jam, 51

K

Keypad, 12
 Keys on keypad, 13

L

Language, 34, 35
 for LUCM, 42
 for LUCMT, 44
 LoadType (1_Reference), 39, 39
 Long Start, 53
 LR Conf, 34, 37
 LUCM05BL, 41
 LUCM12BL, 41
 LUCM18BL, 41
 LUCM1XBL, 41
 LUCM32BL, 41
 LUCMX6BL, 41

M

Magnet trip, 47
 Mode
 "Fault", 67
 "Run", 32
 "Warning", 66
 Off, 31
 Pause, 31
 Ready, 31
 Module, 56
 Motor
 single-phase motor, 34
 1 ph (LoadType), 34
 3 ph (LoadType), 34
 cold, 72
 hot, 72
 self-cooled, 75
 with auxiliary fan, 75

N

New PSW? (82_Lock), 61

O

ONhours (2_Display), 40
 Overload, 48

P

Param dec, 57
 Param hex, 57
 Parity, 55
 Passwd? (81_Unlock), 61
 Password, 60
 Pause (LUCM), 42
 PhasImb (2_Display), 40, 40
 Power circuit, 80
 Power up
 initial, 31
 subsequent, 31
 Powersuite, 77

R

Reference, 56

Reset

automatic, 46

manual, 46

remote, 46

settings, 61

statistics, 61

Reset adjustment, 47

RS 485 serial communication port, 12, 79

S

SelfProtStr (Base), 34

Service temperature, 14

Start-up

beginning, 62

end, 62

Start-up phase, 62

Starter (Base), 34

Statistics, 58

T

TestTrip

for LUCM, 42

for LUCMT, 44

ThermCap (2_Display), 40, 40

Three-phase motor, 34

Trip (2_Display), 40, 40

TripClass, 45

U

Underload, 52

W

Warning

code, 66

name, 66

Warning name

Off-ModID, 66

Warn-Comm, 66

Warn-GF, 66

Warn-Imbal, 66

Warn-IntTmp, 66

Warn-Jam, 66

Warn-LongSt, 66

Warn-OL, 66

Warn-UndrLd, 66

Warning M109, 66

